



DOBEST BRIGHT CO.,LIMITED

中山好倍儿照明有限公司
多贝尔电子科技有限公司



LED Linear Lighting System Catalog

DOBEST BRIGHT CO.,LIMITED

中山好倍儿照明有限公司
多贝尔电子科技有限公司

Web: www.tracklinearlight.com

Factory Address 1: 3rd Floor, No. 26, Pingbei 1st Road, Nanping Science and Technology Industrial Park, Xiangzhou District, Zhuhai City, Guangdong, P.R. China

Factory Address 2: 2nd Floor, 3rd Floor, No. 15, 1st Street, Hongye Road, Caoer, Guzhen Town, Zhongshan City, Guangdong Province

Email: candy@dobestbright.com / sales@dobestbright.com

Tel/Fax: +86-0756-3338786

Whatsapp: +86-18902868159



ABOUT **DOBEST**

DOBEST management has been working in the LED Lighting industry since 2008 and has had its oversea department since 2012. It is a professional manufacturing enterprise that focuses on the research and development and production of lighting fixtures.

DOBEST based in Zhuhai and Zhongshan Guangdong Province, and there are 2000 m² production line and warehouse in ZhongShan and a 500 m² show room and warehouse in Zhuhai.

www.tracklinearlight.com

DOBEST is a professional manufacturer with R&D and production in one, specializing in Led magnetic track lights, led Linear lights and LED Aluminum Profile, led penal lights, etc. Thanks to our inherited commitments to high QA/QC procedures, our operation process is accredited by ISO9001-2015. All of our product is with ETL, CE(EMC&LVD), RoHS, and SAA certifications.

DOBEST has a professional optical design, appearance design, thermal design, structure design, and electronic design engineers team. Our marketing team will collect your requirements, timely feedback to the relevant departments to solve your problems, provide quality and fast after-sales service.

www.tracklinearlight.com

LOTOPUP
Brighten your life

FACTORY

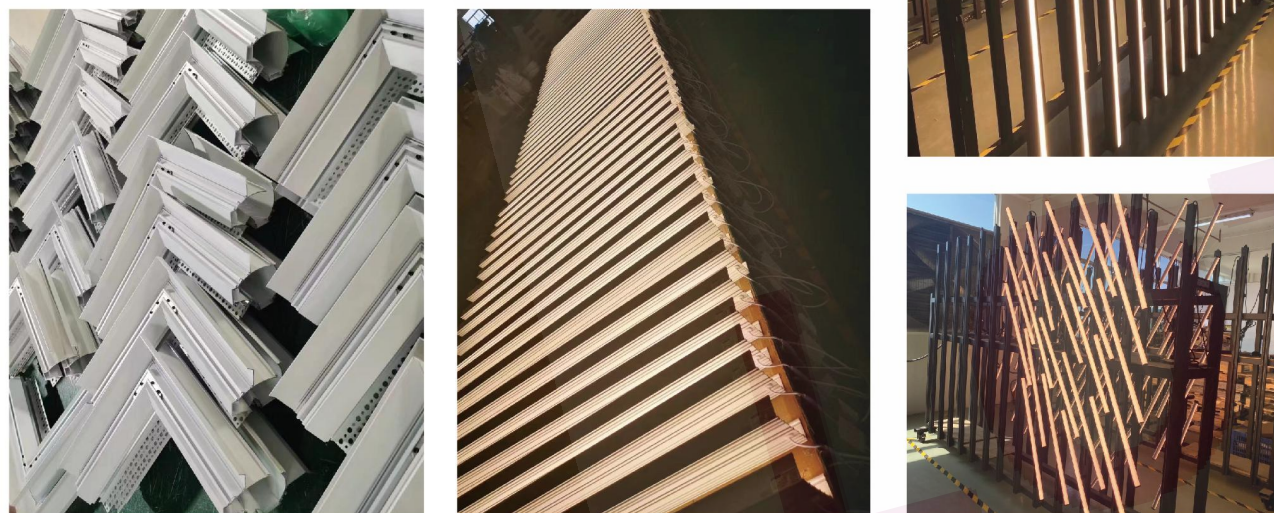
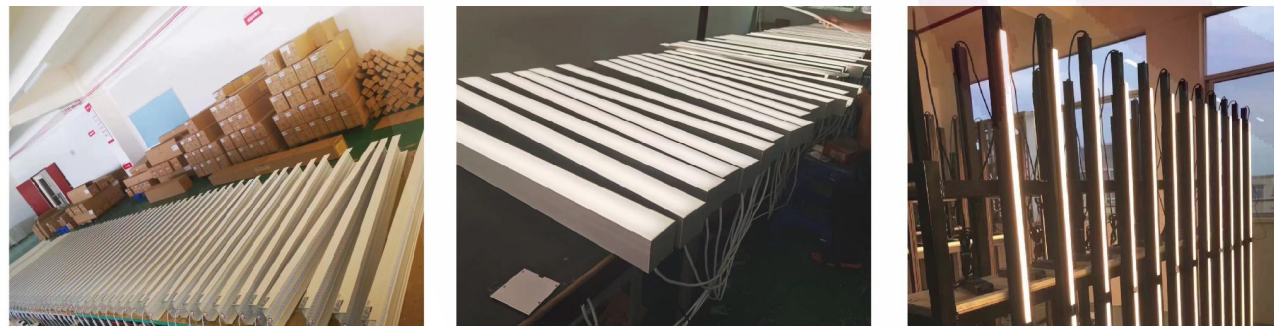
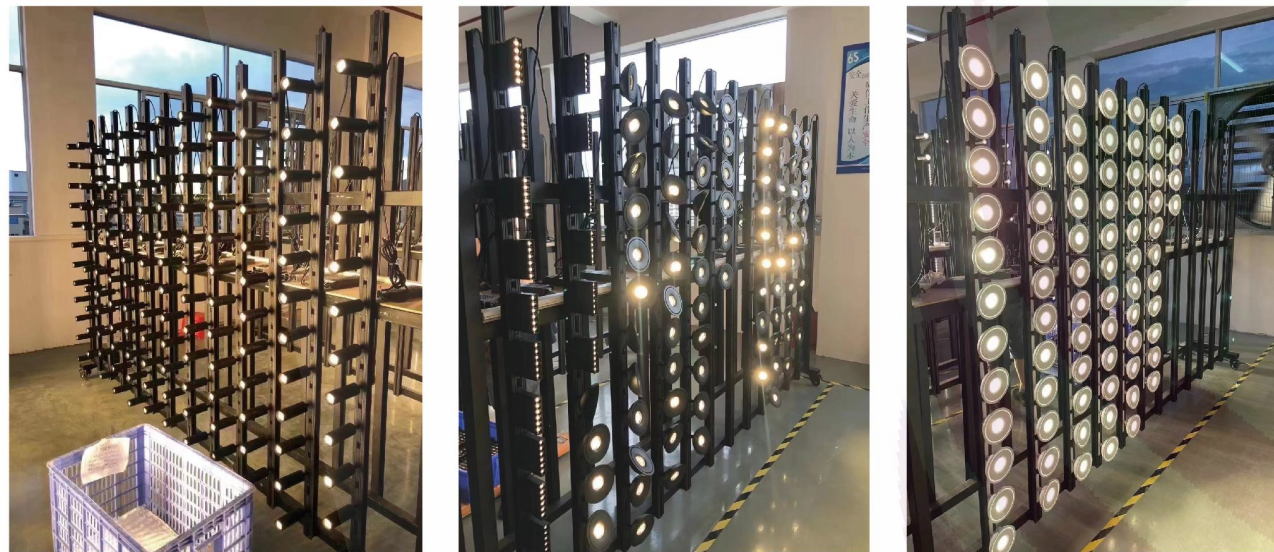

Dobest extrusion workshop



Injection Workshop



Assembly Line



Integrating Sphere Test

CERTIFICATES AND EXHIBITIONS

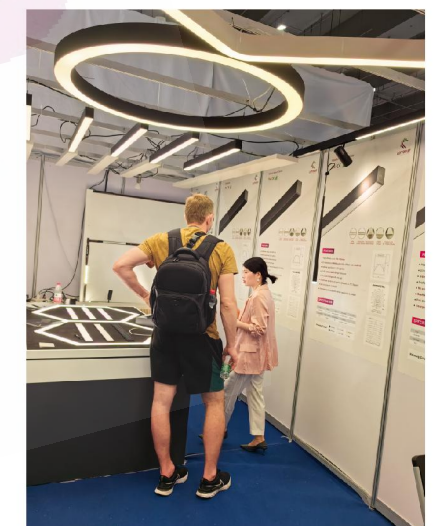
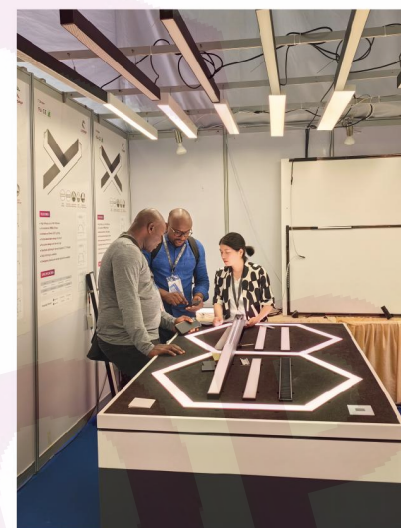
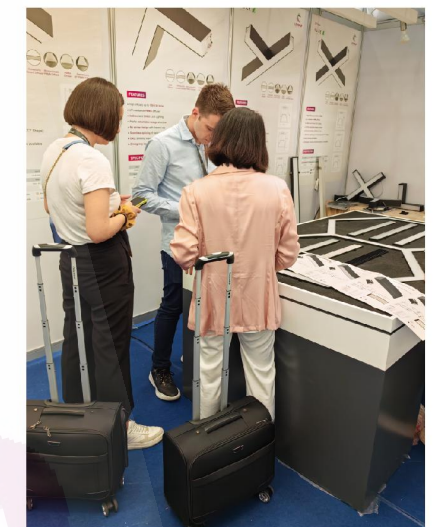
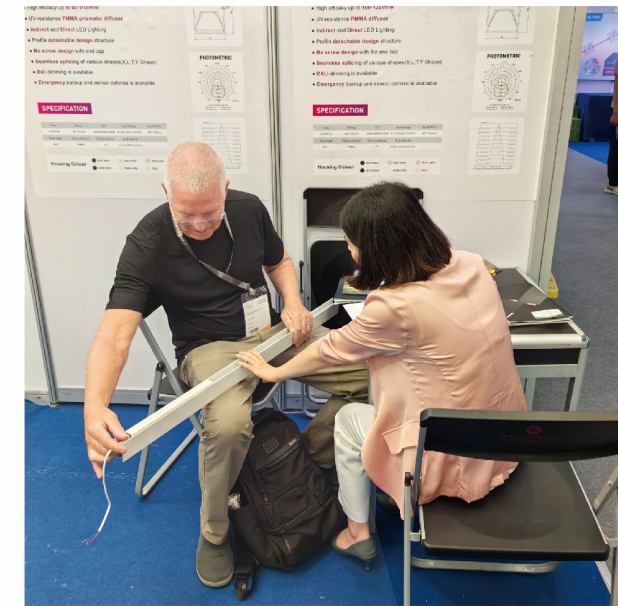

Brigthen your life

DOBEST BRIGHT PROJECT

- Light Planning
- Light Calculation (DIALUX)
- Photometric Simulation
- Customizing Light Solutions
- Comparison Studies
- Product Sourcing

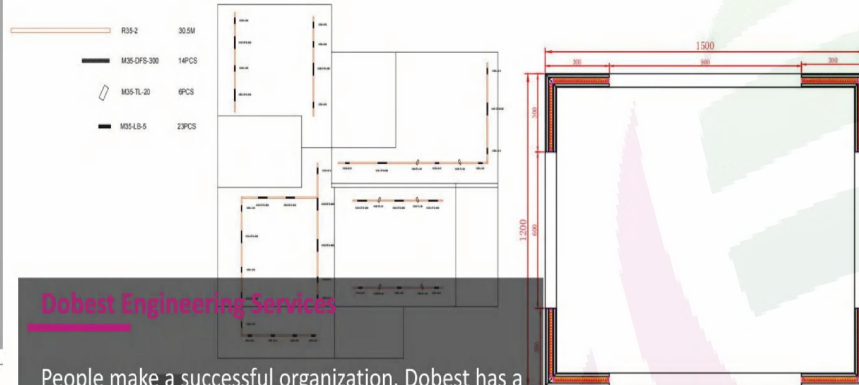

Dobest Engineering Services

People make a successful organization. Dobest has a team of motivated light professionals to offer a multitude of light related services to find the best result for your projects

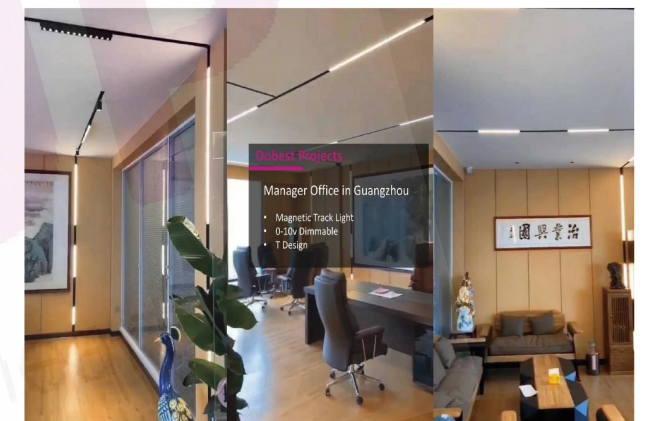
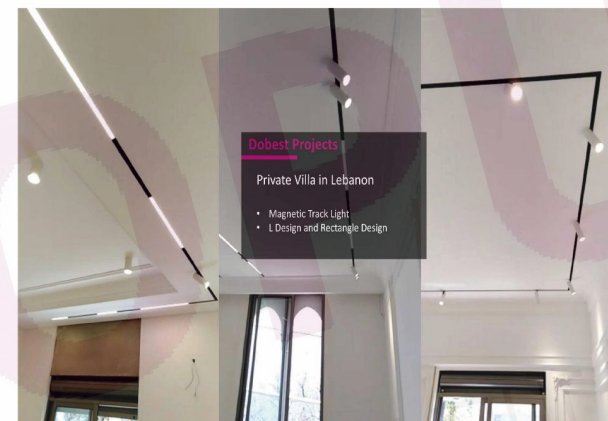
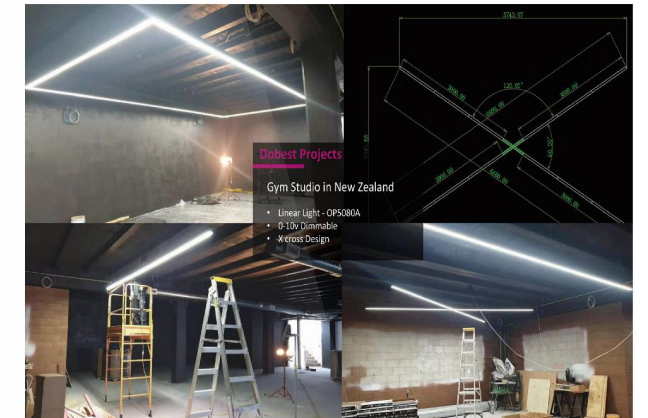
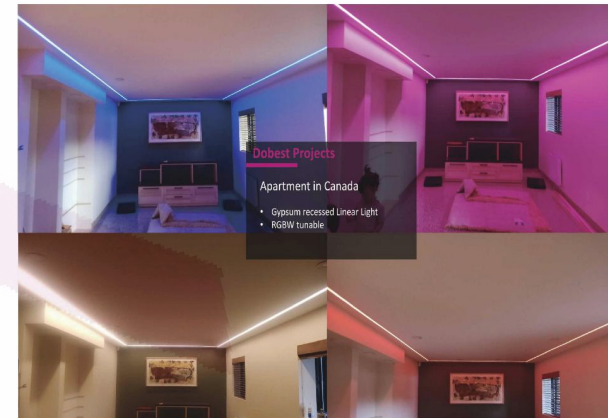
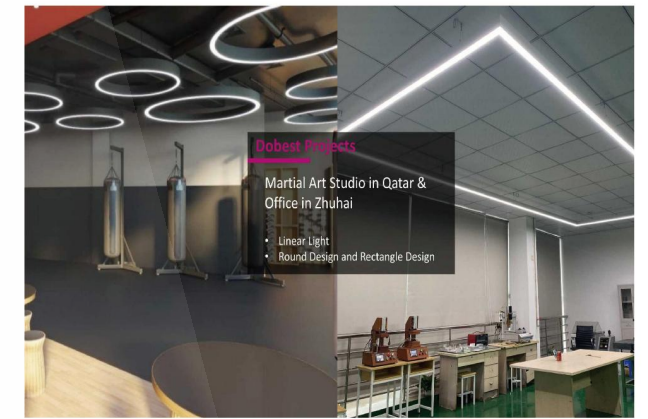
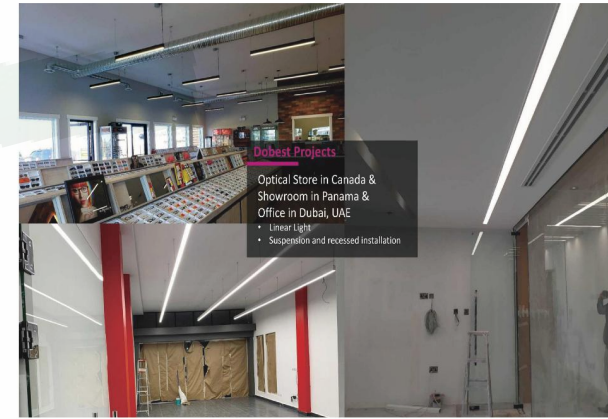
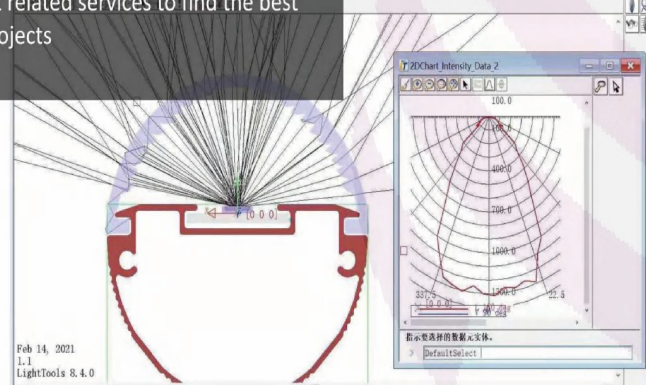
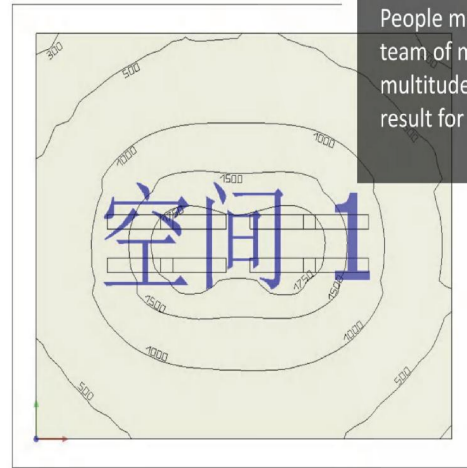

Dobest works together with clients to create fabulous customized lighting. Strong supply chain allow us to offer customized lighting service with reasonable price, satisfied quality. Noted: Only photos that the client has agreed to make public will be displayed.

Brighten your life, warm your heart

办公灯 凤铝高端系列

P01-P09

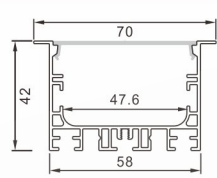

型号: 5842A/03页

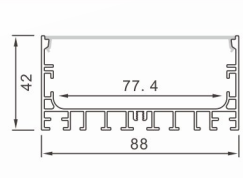

型号: 8842M/06页

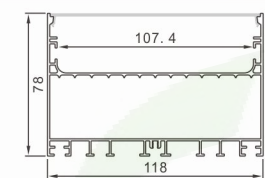

型号: 11878M/08页

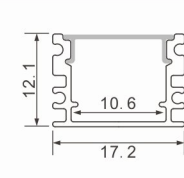

型号: 505/11页

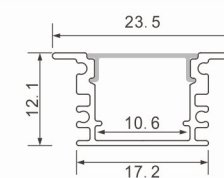

型号: 605/13页

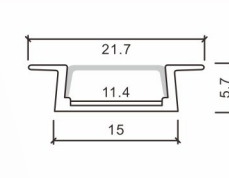

型号: 618/15页

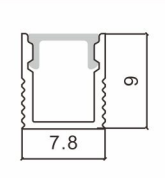

型号: 0809M/17页

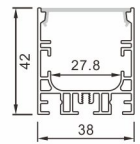

型号: 3842M/02页

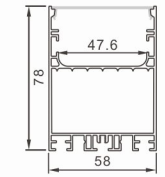

型号: 5878M/04页

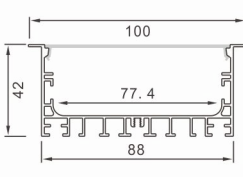

型号: 8842A/06页

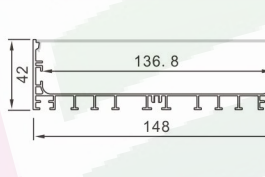

型号: 14842M/08页

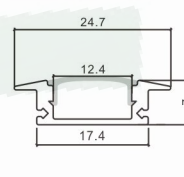

型号: 508/11页

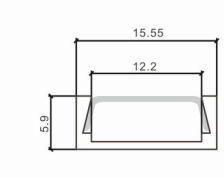

型号: 610/13页

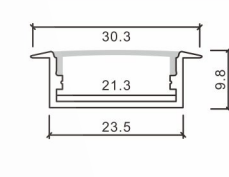

型号: 619/15页

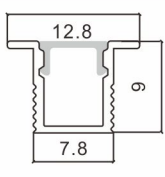

型号: 0809A/17页

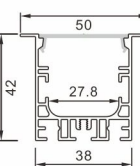

型号: 3842A/02页

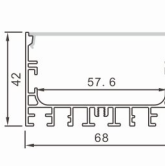

型号: 6842M/04页

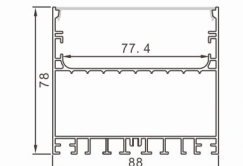

型号: 8878M/06页

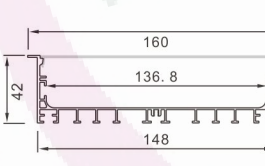

型号: 14842A/08页

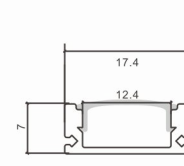

型号: 509/11页

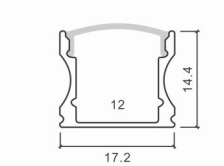

型号: 613/13页

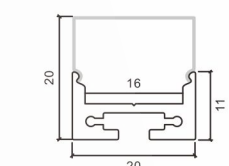

型号: 623/15页

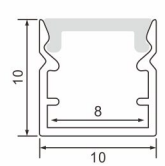

型号: 1010M/17页

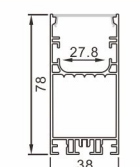

型号: 3878M/02页

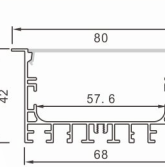

型号: 6842A/04页

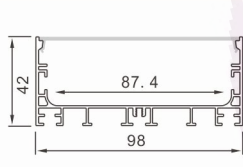

型号: 9842M/06页

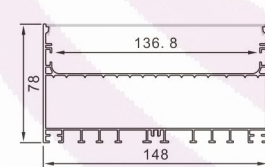

型号: 14878M/09页

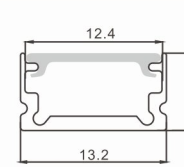

型号: 510/11页

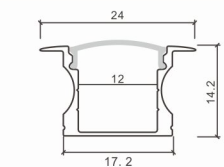

型号: 613B13页

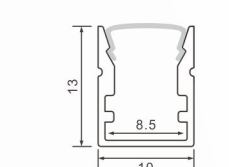

型号: 624/15页

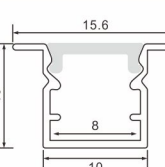

型号: 1010A/17页

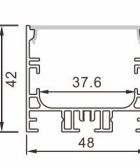

型号: 4842M/02页

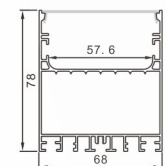

型号: 6878M/04页

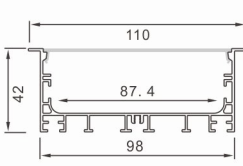

型号: 9842A/07页

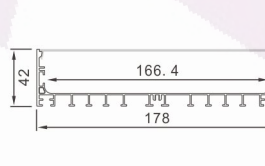

型号: 17842M/09页

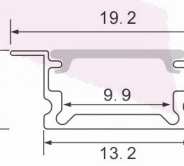

型号: 510A/12页

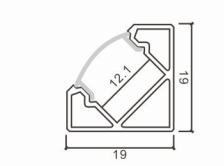

型号: 614/14页

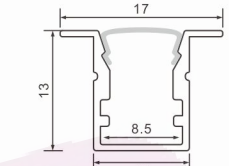

型号: 624A/16页

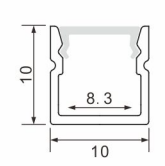

型号: 1010M-1/18页

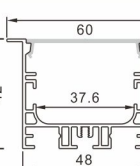

型号: 4842A/03页

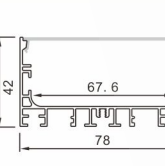

型号: 7842M/05页

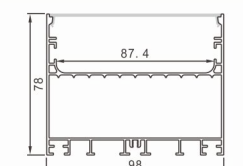

型号: 9878M/07页

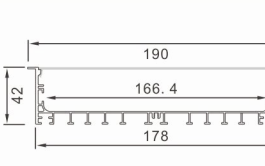

型号: 17842A/09页

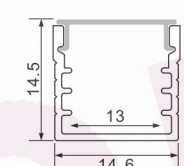

型号: 524/12页

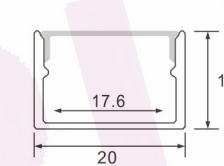

型号: 616/14页

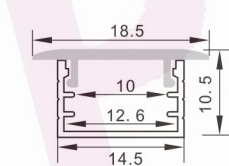

型号: MA-1/16页

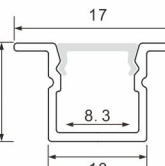

型号: 1010A-1/18页

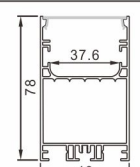

型号: 4878M/03页

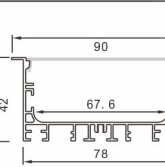

型号: 7842A/05页

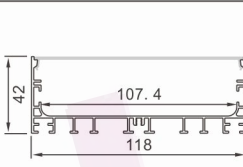

型号: 11842M/07页

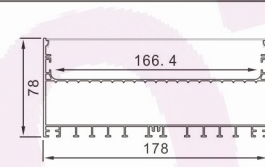

型号: 17878M/09页

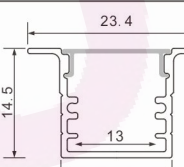

型号: 524A/12页

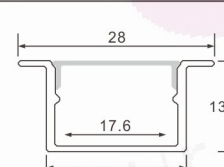

型号: 616A/14页

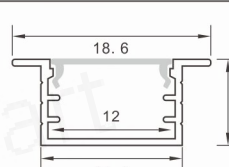

型号: 1409A/16页

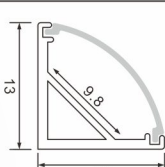

型号: 1313/18页

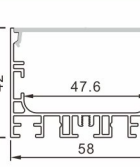

型号: 5842M/03页

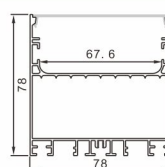

型号: 7878M/05页

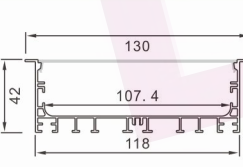

型号: 11842A/08页

硬灯条 铝型材套件

P10-P21

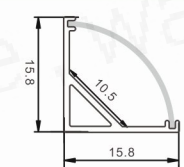

型号: 601/12页

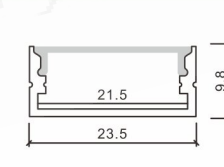

型号: 617/14页

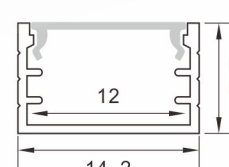

型号: 1409M/16页

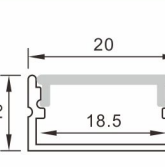

型号: 2010M/18页

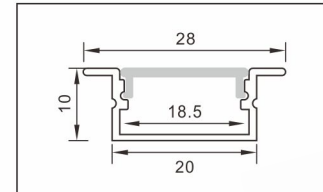

型号: 2010A/19页

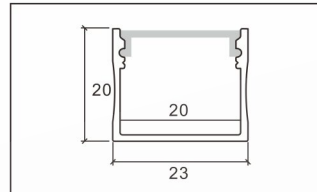

型号: 2320M/21页

线条灯 (办公灯系列)
铝型材套件
P23-P38

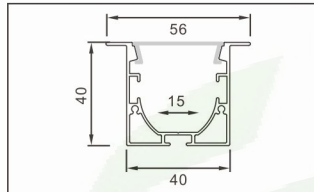

型号: 4040A/25页

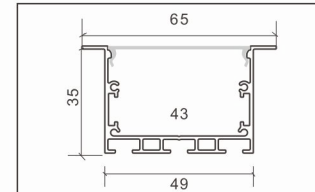

型号: 5035A厚款/28页

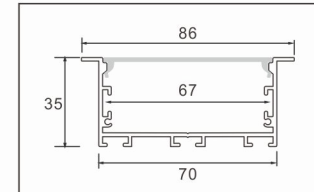

型号: 7035A/30页

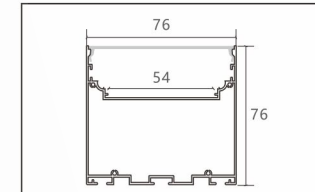

型号: 7676M/32页

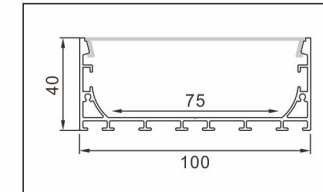

型号: 10040M/34页

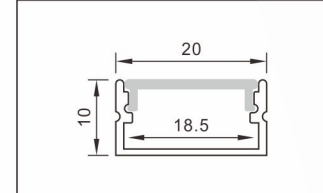

型号: 2010M加厚款/19页

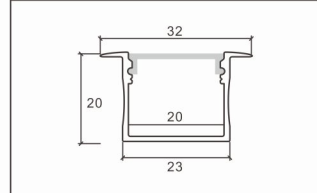

型号: 2320A/21页

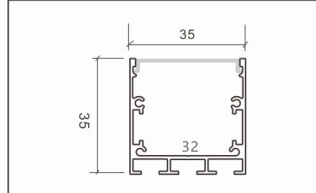

型号: 3535M/24页

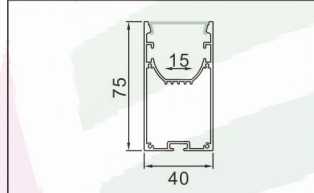

型号: 4075M/26页

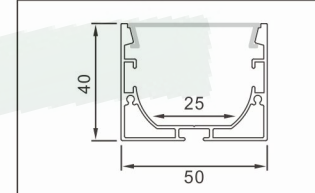

型号: 5040M/28页

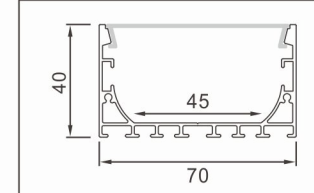

型号: 7040M/30页

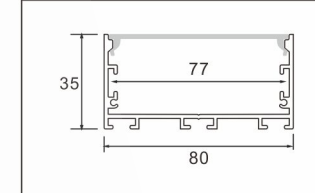

型号: 8035M/32页

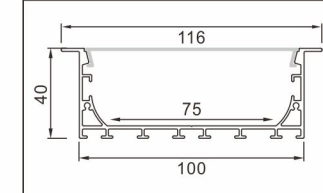

型号: 10040A/34页

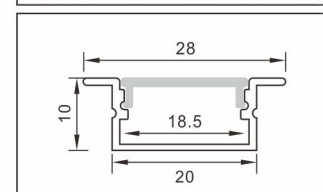

型号: 2010A加厚款/19页

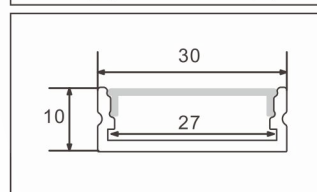

型号: 3010M/21页

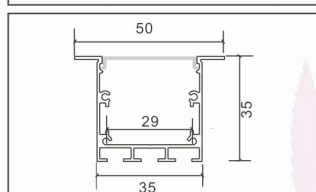

型号: 3535A/24页

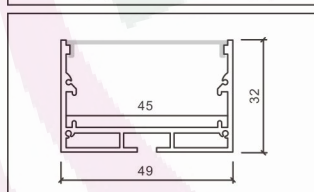

型号: 706/26页

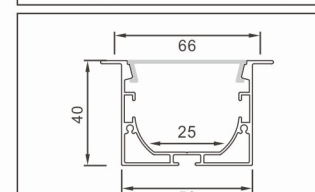

型号: 5040A/28页

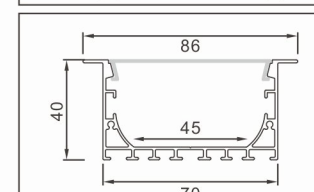

型号: 7040A/30页

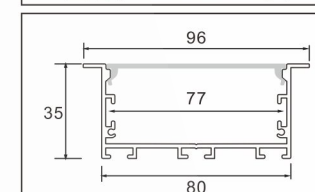

型号: 8035A/32页

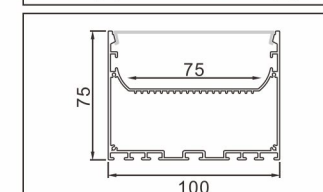

型号: 10075M/34页

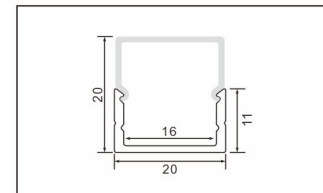

型号: 2011/19页

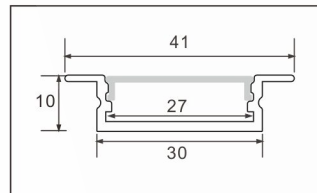

型号: 3010A/21页

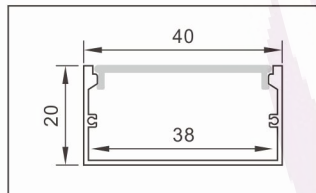

型号: 4020M/24页

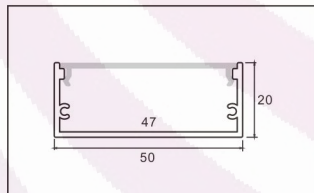

型号: 5020M/26页

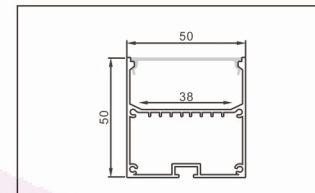

型号: 5050M/28页

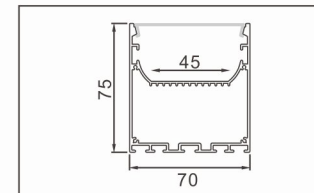

型号: 7075M/31页

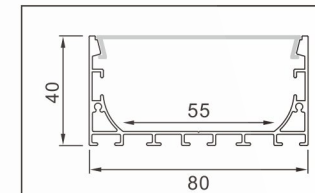

型号: 8040M/33页

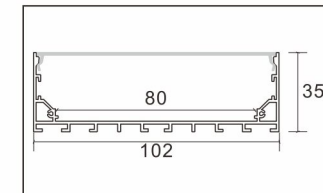

型号: 10235M/35页

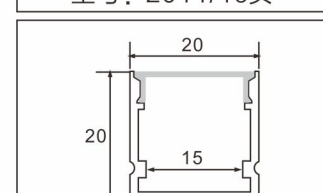

型号: 2020M/20页

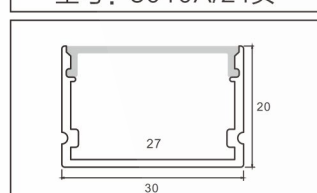

型号: 3020M/22页

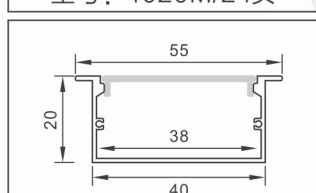

型号: 4020A/24页

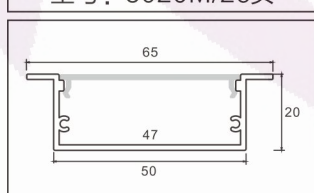

型号: 5020A/26页

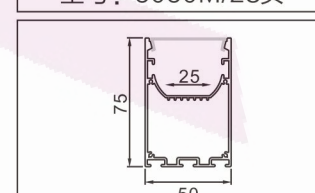

型号: 5075M/29页

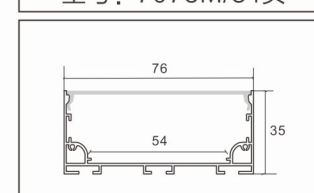

型号: 7635M/31页

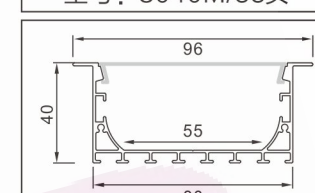

型号: 8040A/33页

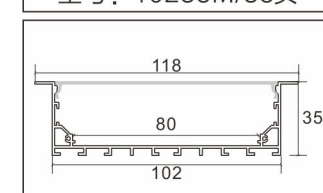

型号: 10235A/35页

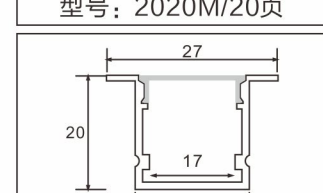

型号: 2020A/20页

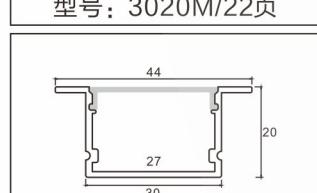

型号: 3020A/22页

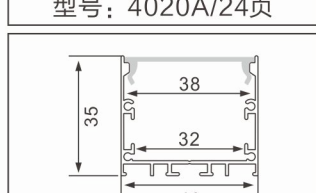

型号: 4035M/25页

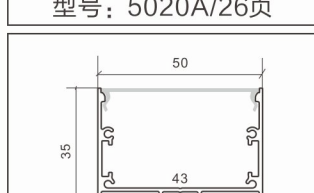

型号: 5035M/27页

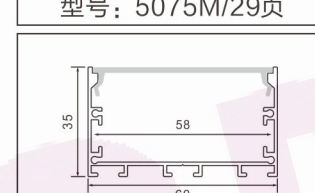

型号: 6035M/29页

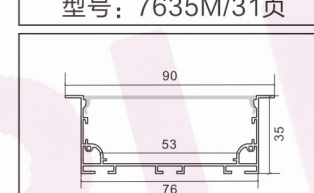

型号: 7635A/31页

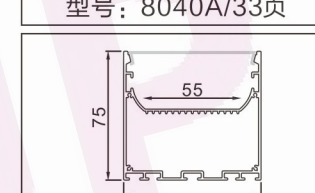

型号: 8075M/33页

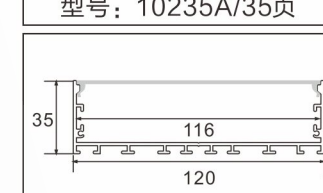

型号: 12035M/35页



型号: 2020M厚款/20页

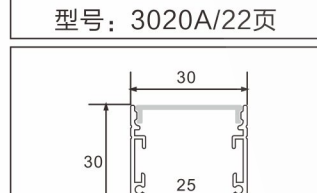

型号: 3030M/22页

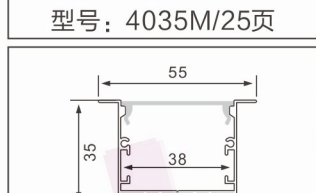

型号: 4035A/25页

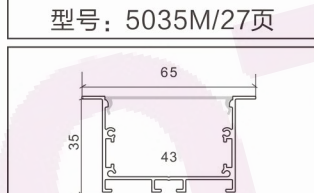

型号: 5035A/27页

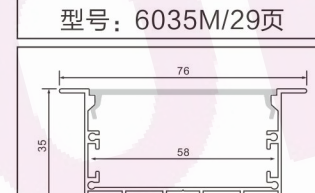

型号: 6035A/29页



型号: 7635M厚款/31页

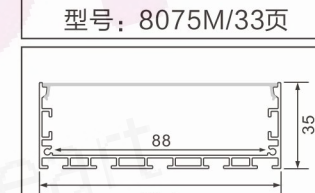

型号: 10035M厚款/33页

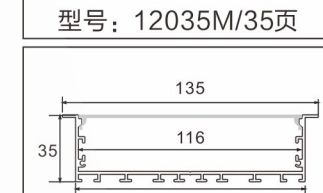

型号: 12035A/36页



型号: 2020A厚款/20页

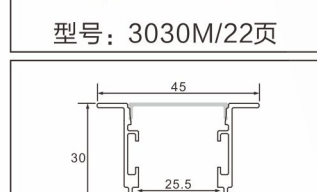

型号: 3030A/22页



型号: 4040M/25页



型号: 5035M厚款/27页

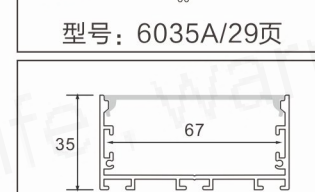

型号: 7035M/30页



型号: 7635A厚款/32页



型号: 10035A厚款/34页

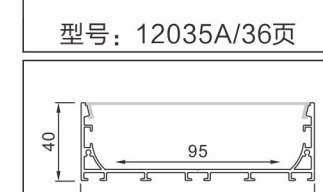

型号: 12040M/36页

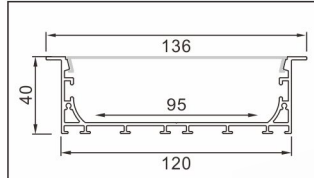

型号: 12040A/36页

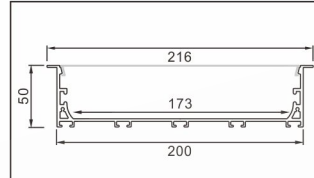

型号: 20050A/38页

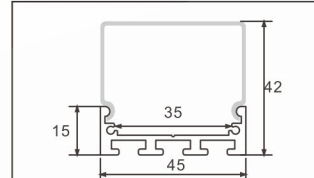

型号: 4542方/42页

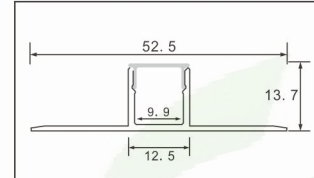

型号: 703/45页

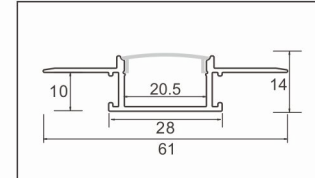

型号: 6114/47页

踩地线条灯
铝型材套件
P50-52

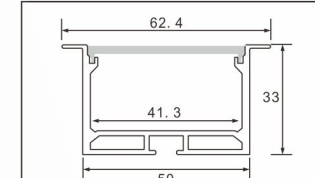

型号: 地踩5032A/52页

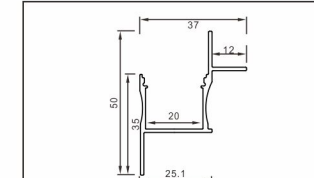

型号: 102/55页

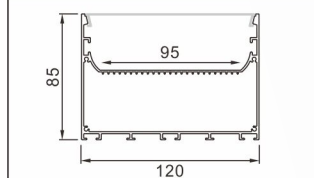

型号: 12085M/36页

夹层灯
铝型材套件
P39-P40

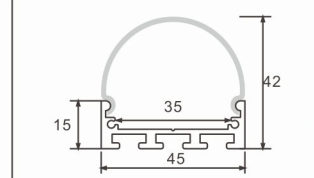

型号: 4542圆/42页

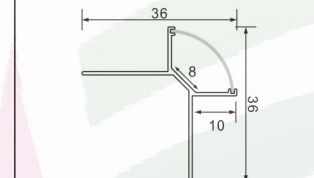

型号: 601花边/45页

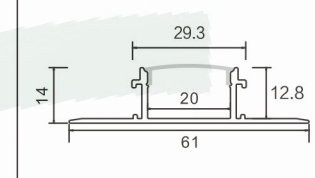

型号: 6114A/47页

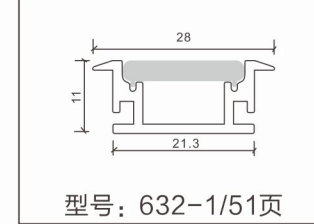

型号: 632-1/51页

洗墙系列
铝型材套件
P53-P59

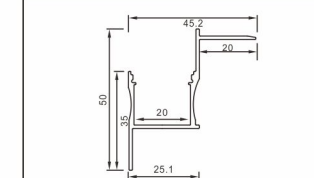

型号: 103/56页

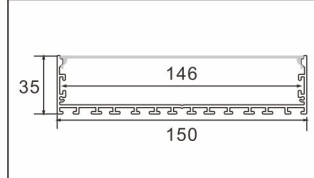

型号: 15035M/37页

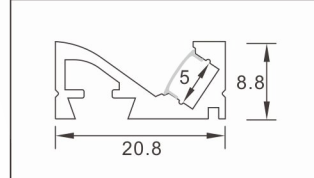

型号: 层板-明/40页

阴阳角线条灯
铝型材套件
P43-P49

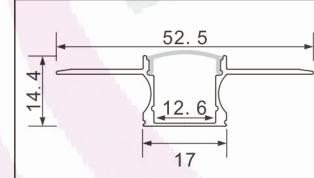

型号: 613花边/45页

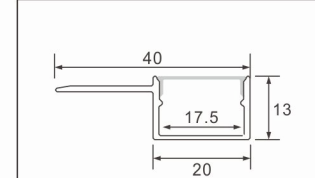

型号: 2013单花边/48页

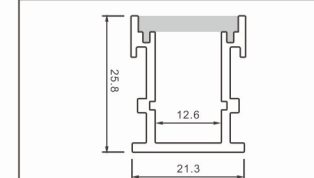

型号: 632/51页

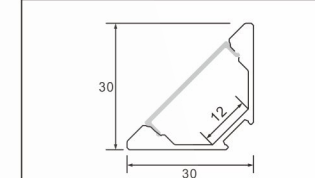

型号: 3030-L/54页

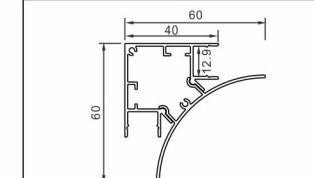

型号: 104/56页

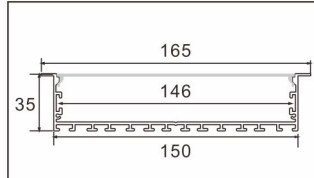

型号: 15035A/37页

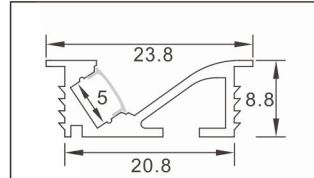

型号: 层板-暗/40页

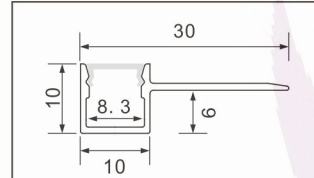

型号: 1010单花边/44页

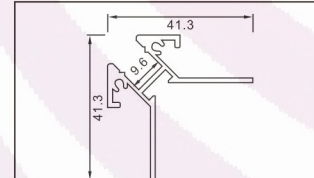

型号: 707阳角/46页

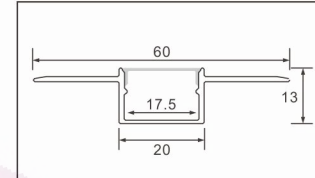

型号: 2013上花边/48页

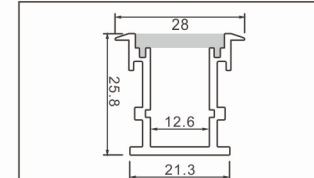

型号: 632A/51页

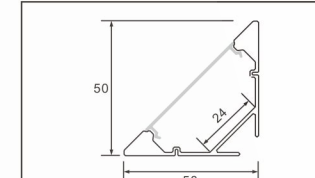

型号: 5050-L/54页

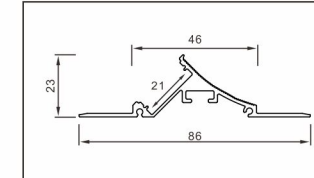

型号: 105/56页

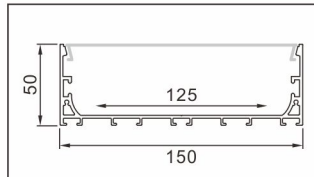

型号: 15050M/37页

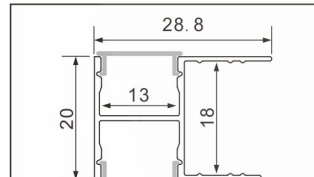

型号: 2028/40页

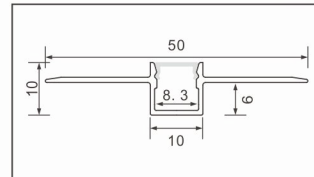

型号: 1010上花边/44页

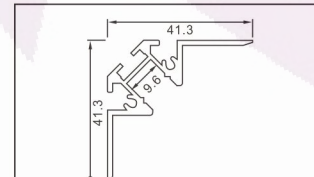

型号: 707阴角/46页

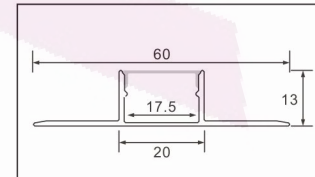

型号: 2013下花边/48页

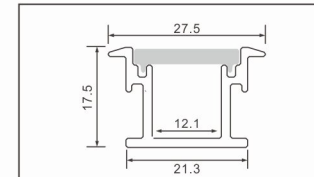

型号: 633/51页

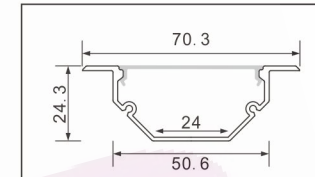

型号: 5050-X/54页

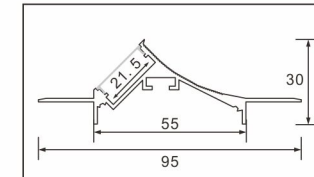

型号: 801/57页

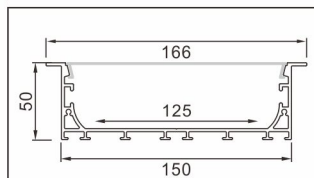

型号: 15050A/37页

多面发光线条灯
铝型材套件
P41-P42

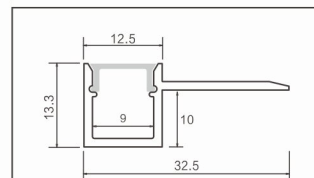

型号: 704/44页

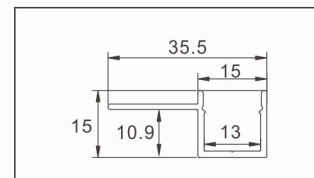

型号: 701米字/46页

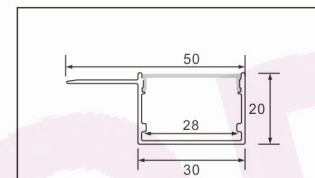

型号: 3020单花边/49页

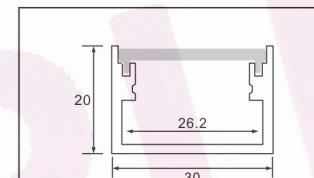

型号: 地踩3020M/52页

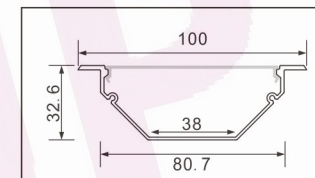

型号: 8080-X/54页

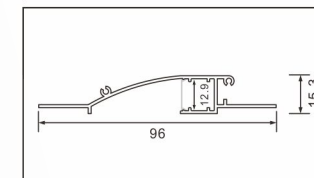

型号: 803/57页

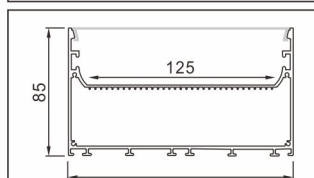

型号: 15085M/38页

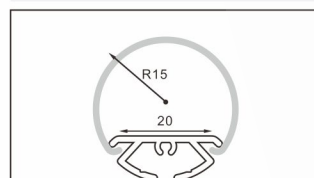

型号: Ø30/42页

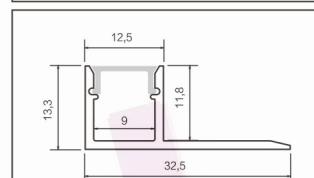

型号: 702/44页

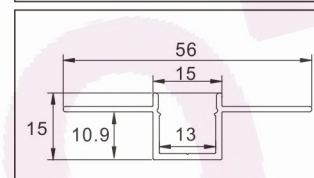

型号: 639米字/47页

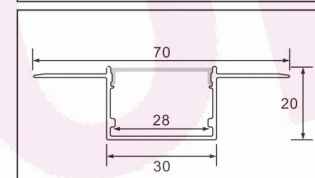

型号: 3020上花边/49页

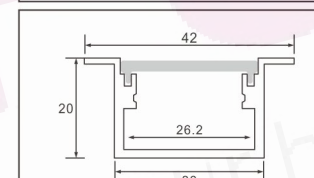

型号: 地踩3020A/52页

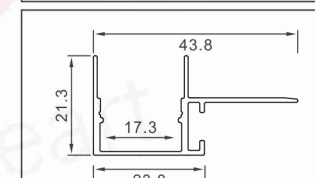

型号: 101/55页

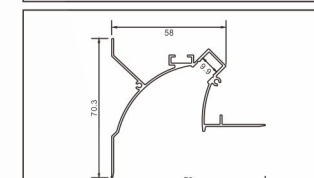

型号: 106/57页

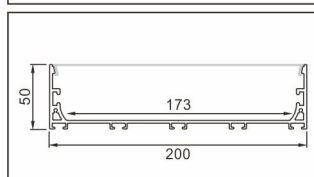

型号: 20050M/38页

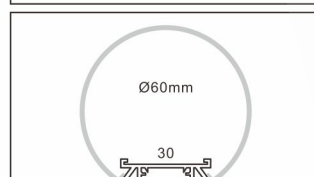

型号: Ø60/42页

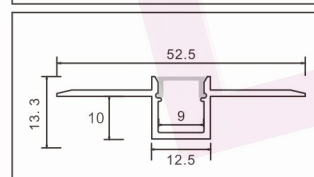

型号: 639新款/45页

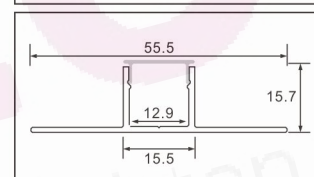

型号: 639米字下花边/47页

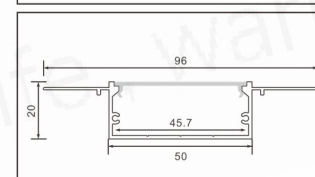

型号: 9620/49页

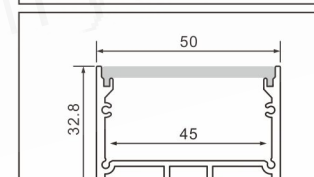

型号: 地踩5032M/52页

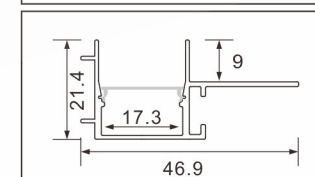

型号: 新款101/55页

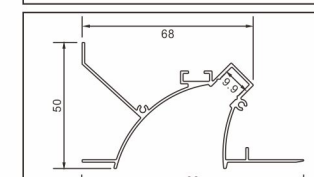

型号: 107/58页

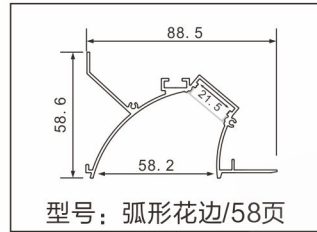

型号: 弧形花边/58页

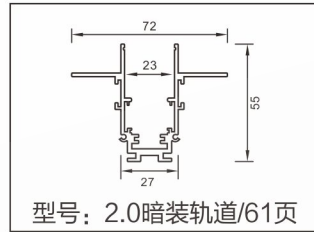

型号: 2.0暗装轨道/61页

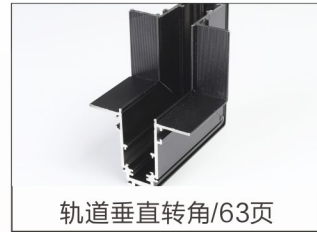

轨道垂直转角/63页

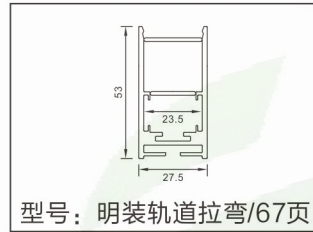

型号: 明装轨道拉弯/67页

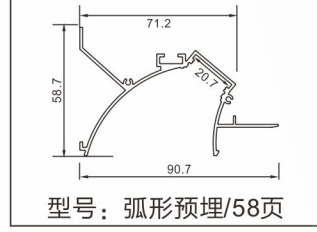

型号: 弧形预埋/58页

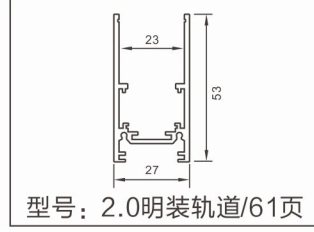

型号: 2.0明装轨道/61页



泛光灯/64页

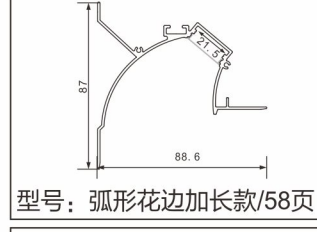
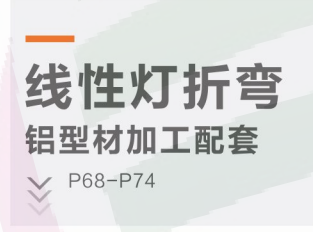

型号: 弧形花边加长款/58页

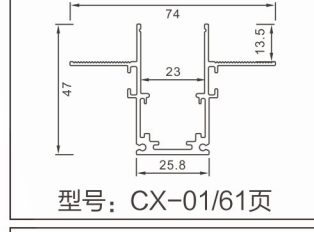

型号: CX-01/61页



格栅灯/64页

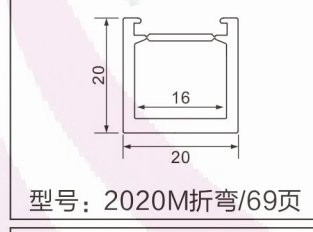

型号: 2020M折弯/69页

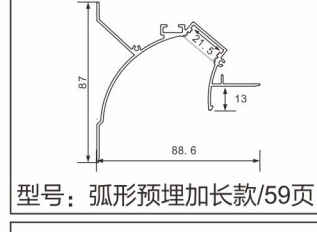

型号: 弧形预埋加长款/59页

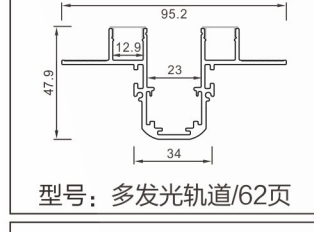

型号: 多发光轨道/62页



轨道灯/64页

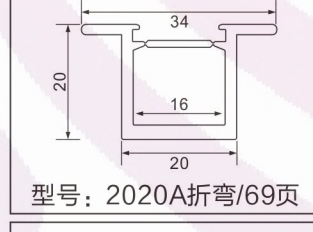

型号: 2020A折弯/69页

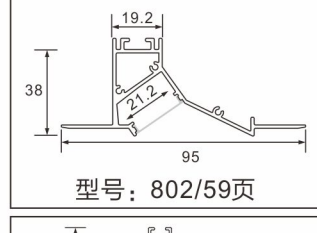

型号: 802/59页

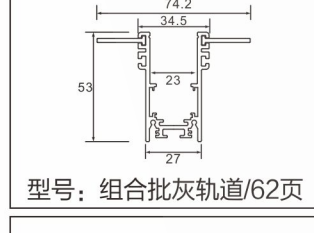

型号: 组合批灰轨道/62页



折叠灯/65页

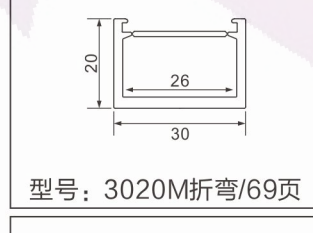

型号: 3020M折弯/69页



型号: 半圆回光槽/59页



型号: 组合预埋轨道/62页



模块/65页

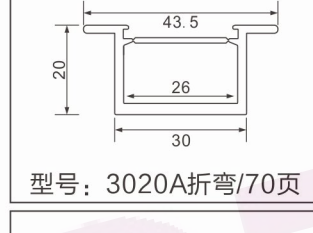

型号: 3020A折弯/70页

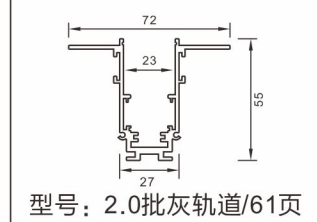

型号: 2.0批灰轨道/61页



型号: 组合明装轨道/62页

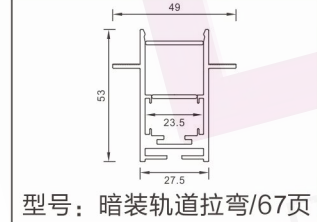
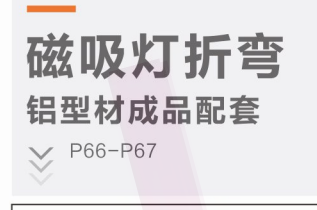

型号: 暗装轨道拉弯/67页

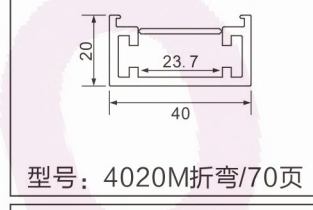

型号: 4020M折弯/70页

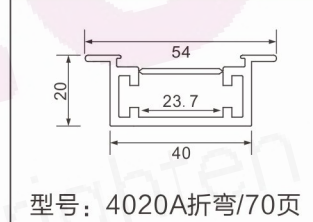

型号: 4020A折弯/70页

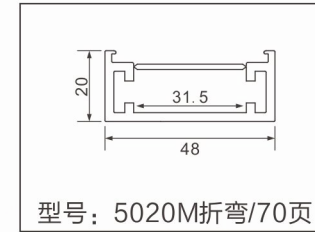

型号: 5020M折弯/70页

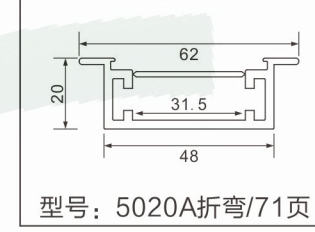

型号: 5020A折弯/71页

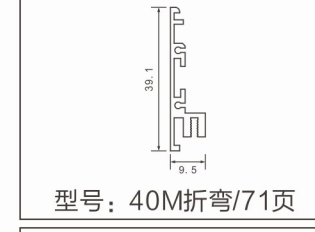

型号: 40M折弯/71页



型号: 40A折弯/71页



型号: 70M折弯/72页



型号: 70A折弯/72页

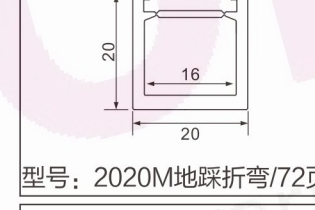

型号: 2020M地踩折弯/72页

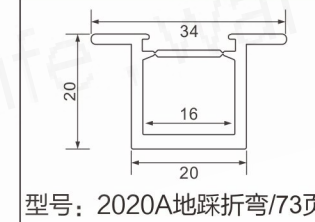

型号: 2020A地踩折弯/73页

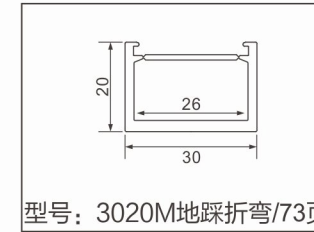

型号: 3020M地踩折弯/73页

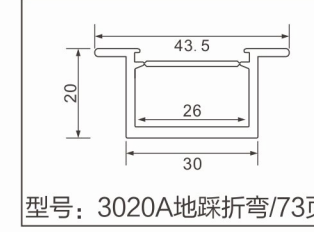

型号: 3020A地踩折弯/73页

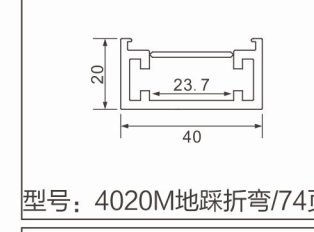

型号: 4020M地踩折弯/74页

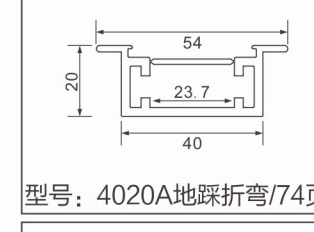

型号: 4020A地踩折弯/74页

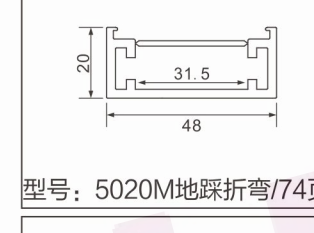

型号: 5020M地踩折弯/74页

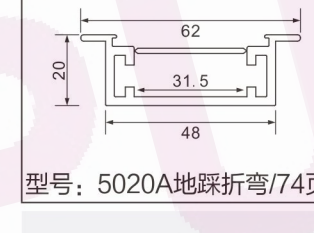

型号: 5020A地踩折弯/74页



软灯带光源



硬灯条光源



台湾明纬开关电源



磁吸灯内置电源

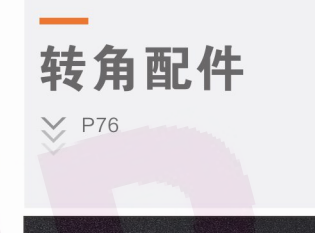

转角配件



连接片/76页



吊线



王字卡扣(吸顶用)



宽卡扣(吸顶用)



单边卡簧(嵌装开孔用)



卡簧(嵌装开孔用)

办公灯凤铝高端系列

铝型材套件

»» P01-P09

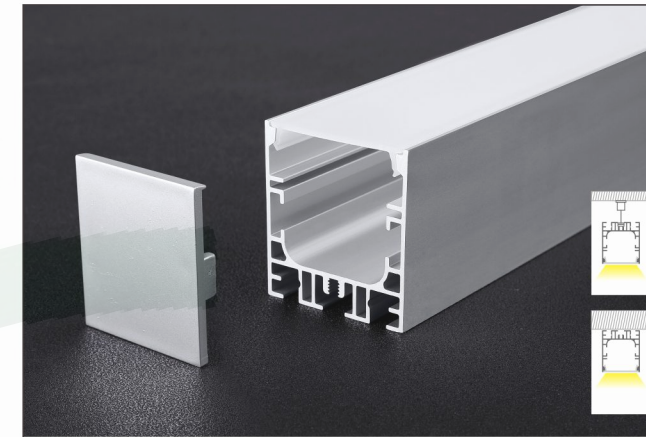

3842M

产品参数

尺寸: Lx38x42mm
材质: 6063-T5 铝合金
表面: 氧化铝本色/喷漆 (黑色/白色)
PC罩: 乳白/黑色/亚克力磨砂可选
适用: 20MM软灯带/硬灯条

Description

size: Lx38x42mm
Material: 6063-T5
Surface: Silver / black / white Anodized
PC cover: Milky white/black/acrylic matte
Apply: LED Strips and PCB 20mm

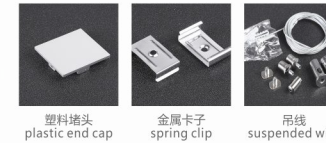
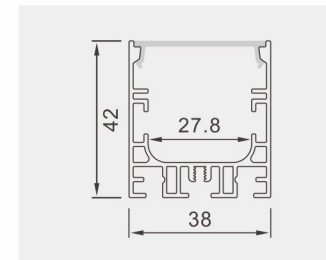

塑料堵头 plastic end cap 金属卡子 spring clip 吊线 suspended wire

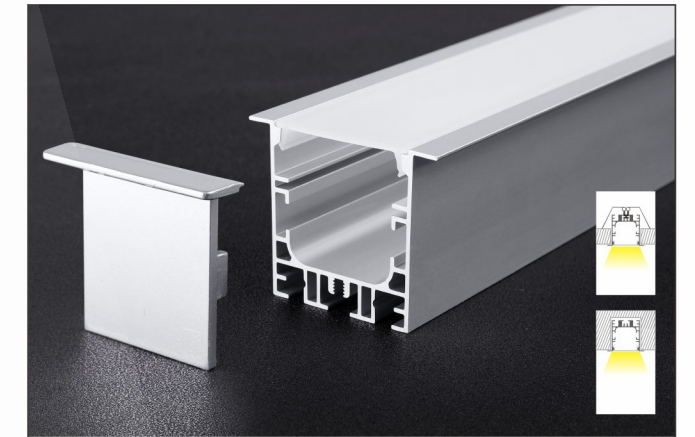

3842A

产品参数

尺寸: Lx50x42mm
材质: 6063-T5 铝合金
表面: 氧化铝本色/喷漆 (黑色/白色)
PC罩: 乳白/黑色/亚克力磨砂可选
适用: 20MM软灯带/硬灯条

Description

size: Lx50x42mm
Material: 6063-T5
Surface: Silver / black / white Anodized
PC cover: Milky white/black/acrylic matte
Apply: LED Strips and PCB 20mm

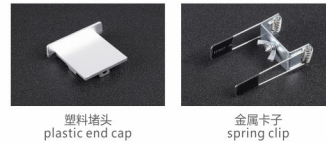
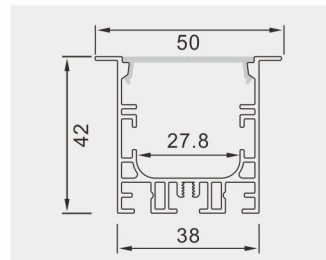

塑料堵头 plastic end cap 金属卡子 spring clip

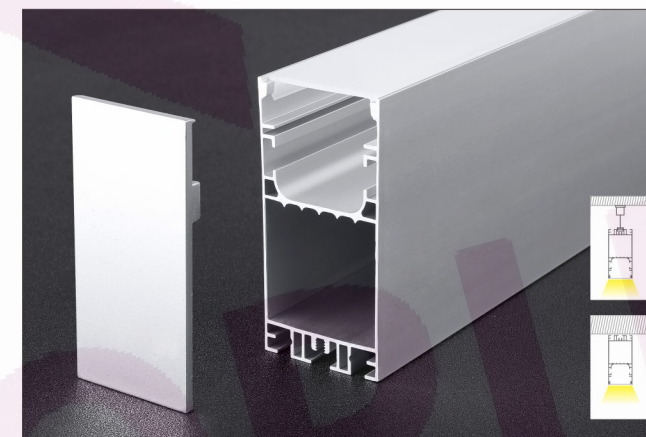

3878M

产品参数

尺寸: Lx38x78mm
材质: 6063-T5 铝合金
表面: 氧化铝本色/喷漆 (黑色/白色)
PC罩: 乳白/黑色/亚克力磨砂可选
适用: 20MM软灯带/硬灯条

Description

size: Lx38x78mm
Material: 6063-T5
Surface: Silver / black / white Anodized
PC cover: Milky white/black/acrylic matte
Apply: LED Strips and PCB 20mm

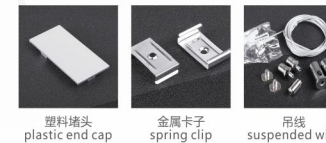
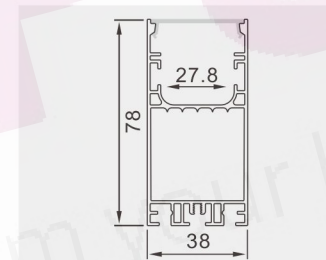

塑料堵头 plastic end cap 金属卡子 spring clip 吊线 suspended wire

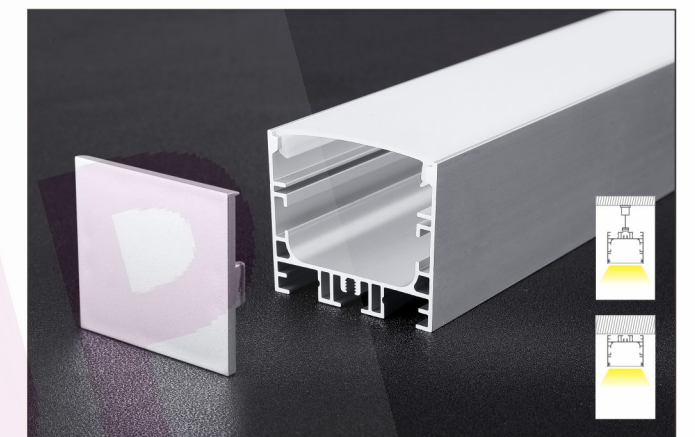

4842M

产品参数

尺寸: Lx48x42mm
材质: 6063-T5 铝合金
表面: 氧化铝本色/喷漆 (黑色/白色)
PC罩: 乳白/黑色/亚克力磨砂可选
适用: 30MM软灯带/硬灯条

Description

size: Lx48x42mm
Material: 6063-T5
Surface: Silver / black / white Anodized
PC cover: Milky white/black/acrylic matte
Apply: LED Strips and PCB 30mm

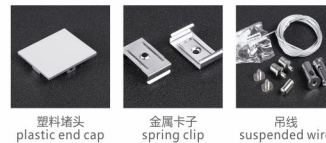
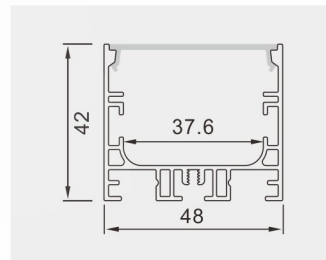

塑料堵头 plastic end cap 金属卡子 spring clip 吊线 suspended wire

2023
NEW STYLE

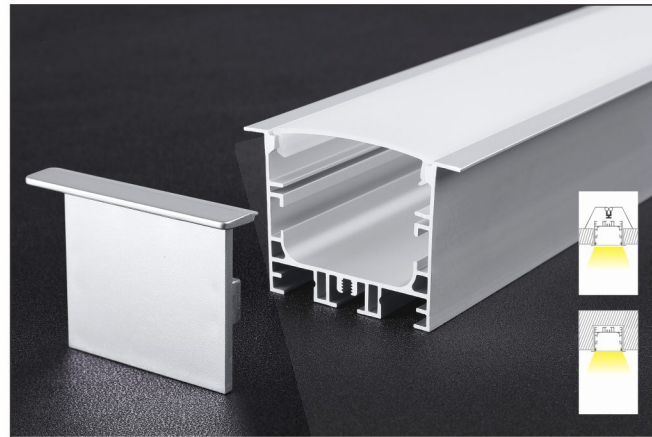

4842A

产品参数

尺寸: Lx60x42mm
材质: 6063-T5 铝合金
表面: 氧化铝本色/喷漆 (黑色/白色)
PC罩: 乳白/黑色/亚克力磨砂可选
适用: 30MM软灯带/硬灯条

Description

size: Lx60x42mm
Material: 6063-T5
Surface: Silver / black / white Anodized
PC cover: Milky white/black/acrylic matte
Apply: LED Strips and PCB 30mm

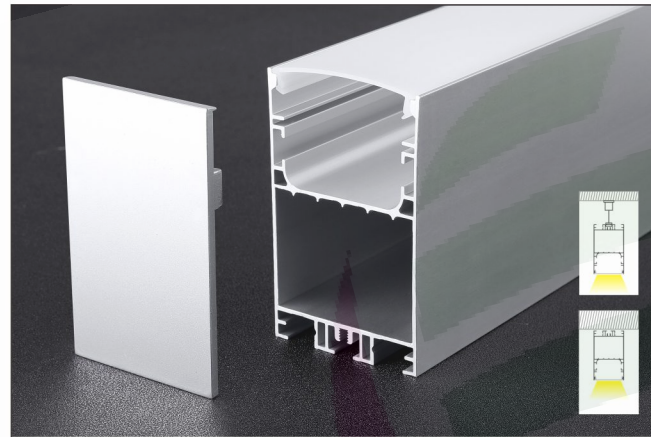
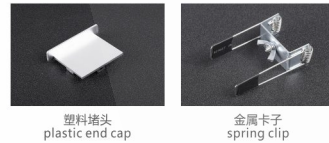
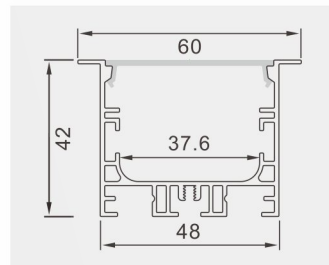

4878M

产品参数

尺寸: Lx48x78mm
材质: 6063-T5 铝合金
表面: 氧化铝本色/喷漆 (黑色/白色)
PC罩: 乳白/黑色/亚克力磨砂可选
适用: 30MM软灯带/硬灯条

Description

size: Lx48x78mm
Material: 6063-T5
Surface: Silver / black / white Anodized
PC cover: Milky white/black/acrylic matte
Apply: LED Strips and PCB 30mm

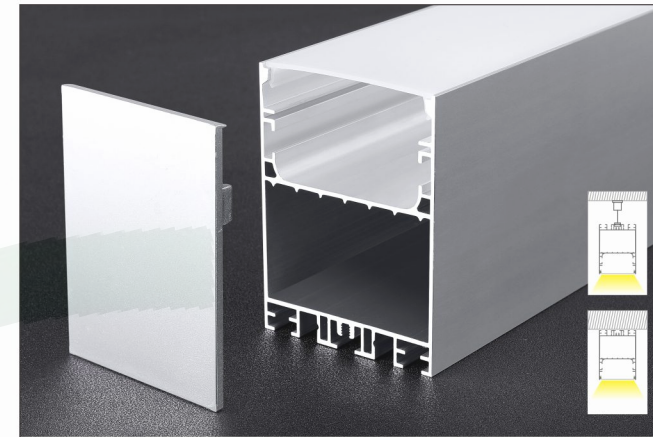
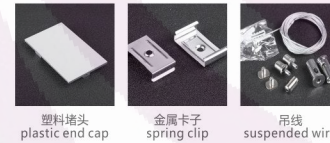
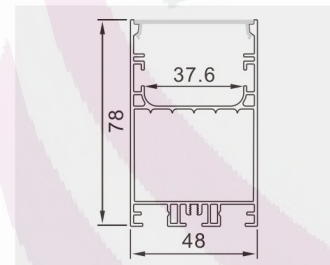

5878M

产品参数

尺寸: Lx58x78mm
材质: 6063-T5 铝合金
表面: 氧化铝本色/喷漆 (黑色/白色)
PC罩: 乳白/黑色/亚克力磨砂可选
适用: 40MM软灯带/硬灯条

Description

size: Lx58x78mm
Material: 6063-T5
Surface: Silver / black / white Anodized
PC cover: Milky white/black/acrylic matte
Apply: LED Strips and PCB 40mm

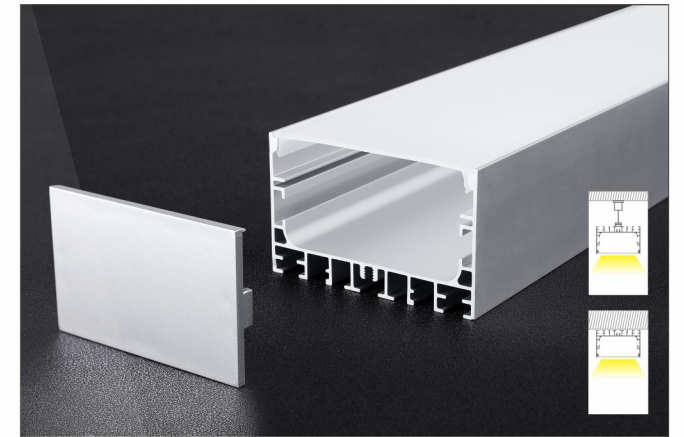
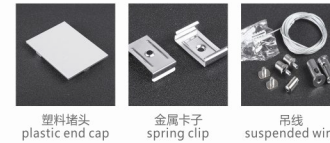
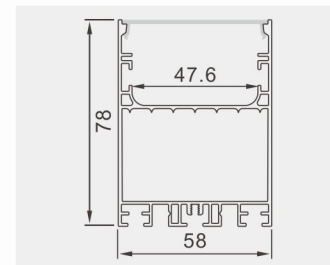

6842M

产品参数

尺寸: Lx68x42mm
材质: 6063-T5 铝合金
表面: 氧化铝本色/喷漆 (黑色/白色)
PC罩: 乳白/黑色/亚克力磨砂可选
适用: 50MM软灯带/硬灯条

Description

size: Lx68x42mm
Material: 6063-T5
Surface: Silver / black / white Anodized
PC cover: Milky white/black/acrylic matte
Apply: LED Strips and PCB 50mm

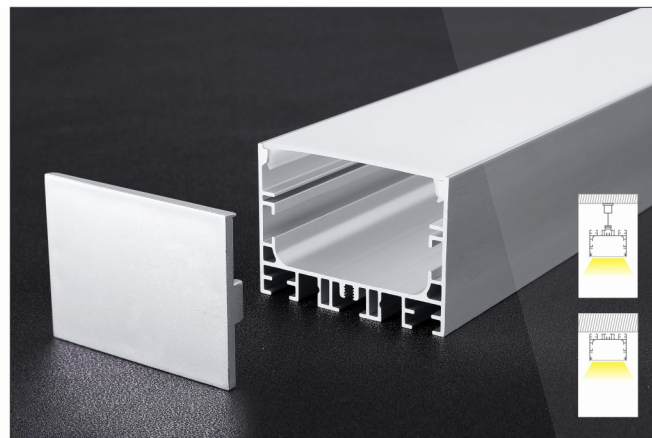
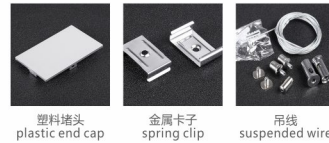
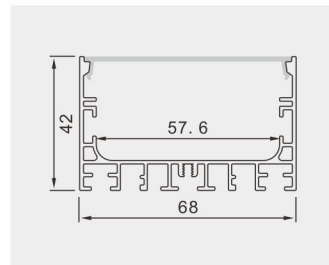

5842M

产品参数

尺寸: Lx58x42mm
材质: 6063-T5 铝合金
表面: 氧化铝本色/喷漆 (黑色/白色)
PC罩: 乳白/黑色/亚克力磨砂可选
适用: 40MM软灯带/硬灯条

Description

size: Lx58x42mm
Material: 6063-T5
Surface: Silver / black / white Anodized
PC cover: Milky white/black/acrylic matte
Apply: LED Strips and PCB 40mm

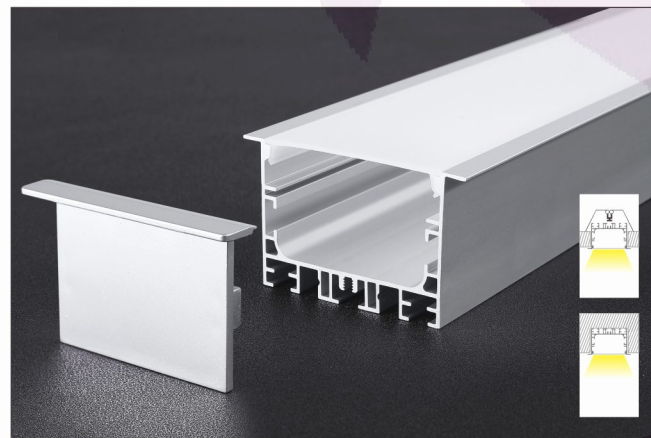
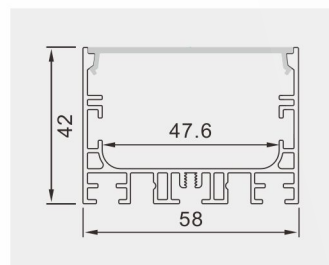

5842A

产品参数

尺寸: Lx70x42mm
材质: 6063-T5 铝合金
表面: 氧化铝本色/喷漆 (黑色/白色)
PC罩: 乳白/黑色/亚克力磨砂可选
适用: 40MM软灯带/硬灯条

Description

size: Lx70x42mm
Material: 6063-T5
Surface: Silver / black / white Anodized
PC cover: Milky white/black/acrylic matte
Apply: LED Strips and PCB 40mm

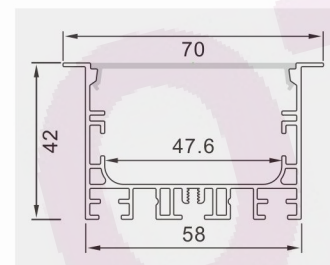

6842A

产品参数

尺寸: Lx80x42mm
材质: 6063-T5 铝合金
表面: 氧化铝本色/喷漆 (黑色/白色)
PC罩: 乳白/黑色/亚克力磨砂可选
适用: 50MM软灯带/硬灯条

Description

size: Lx80x42mm
Material: 6063-T5
Surface: Silver / black / white Anodized
PC cover: Milky white/black/acrylic matte
Apply: LED Strips and PCB 50mm

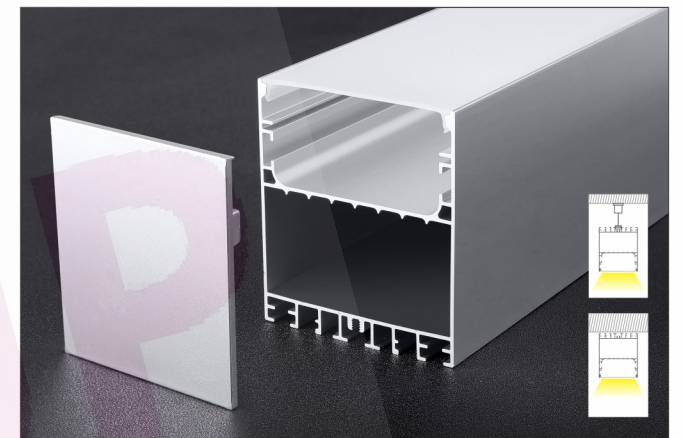
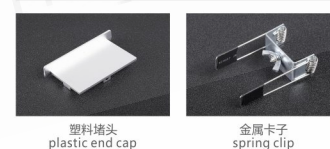
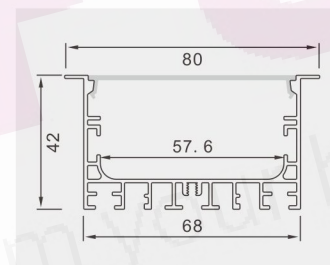

6878M

产品参数

尺寸: Lx68x78mm
材质: 6063-T5 铝合金
表面: 氧化铝本色/喷漆 (黑色/白色)
PC罩: 乳白/黑色/亚克力磨砂可选
适用: 50MM软灯带/硬灯条

Description

size: Lx68x78mm
Material: 6063-T5
Surface: Silver / black / white Anodized
PC cover: Milky white/black/acrylic matte
Apply: LED Strips and PCB 50mm

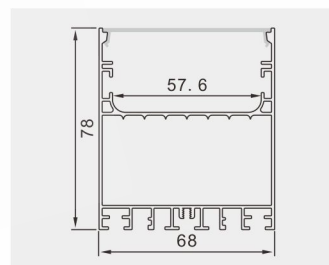

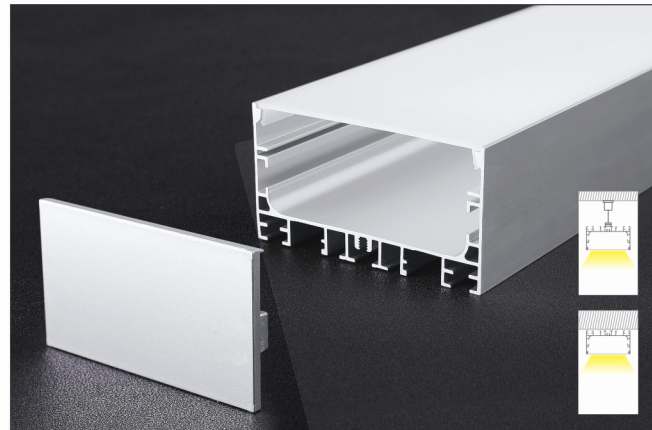

7842M

产品参数

尺寸: Lx78x42mm
材质: 6063-T5 铝合金
表面: 氧化铝本色/喷漆 (黑色/白色)
PC罩: 乳白/黑色/亚克力磨砂可选
适用: 60MM软灯带/硬灯条

Description

size: Lx78x42mm
Material: 6063-T5
Surface: Silver / black / white Anodized
PC cover: Milky white/black/acrylic matte
Apply: LED Strips and PCB 60mm

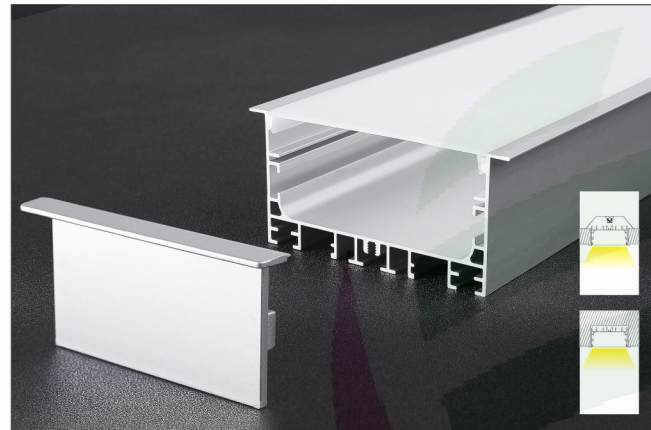
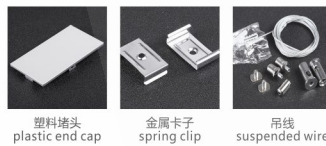
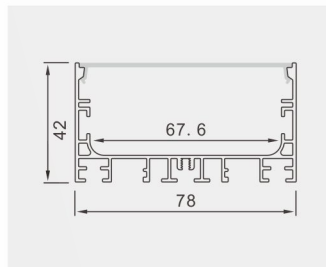

7842A

产品参数

尺寸: Lx90x42mm
材质: 6063-T5 铝合金
表面: 氧化铝本色/喷漆 (黑色/白色)
PC罩: 乳白/黑色/亚克力磨砂可选
适用: 60MM软灯带/硬灯条

Description

size: Lx90x42mm
Material: 6063-T5
Surface: Silver / black / white Anodized
PC cover: Milky white/black/acrylic matte
Apply: LED Strips and PCB 60mm

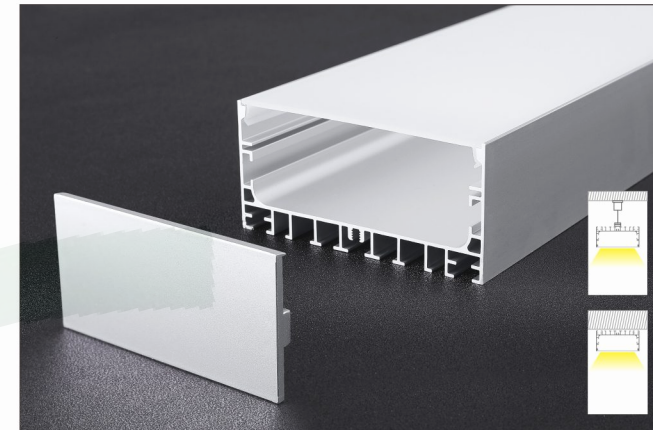
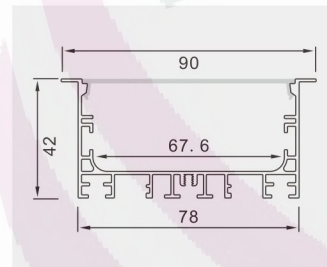

8842M

产品参数

尺寸: Lx88x42mm
材质: 6063-T5 铝合金
表面: 氧化铝本色/喷漆 (黑色/白色)
PC罩: 乳白/黑色/亚克力磨砂可选
适用: 70MM软灯带/硬灯条

Description

size: Lx88x42mm
Material: 6063-T5
Surface: Silver / black / white Anodized
PC cover: Milky white/black/acrylic matte
Apply: LED Strips and PCB 70mm

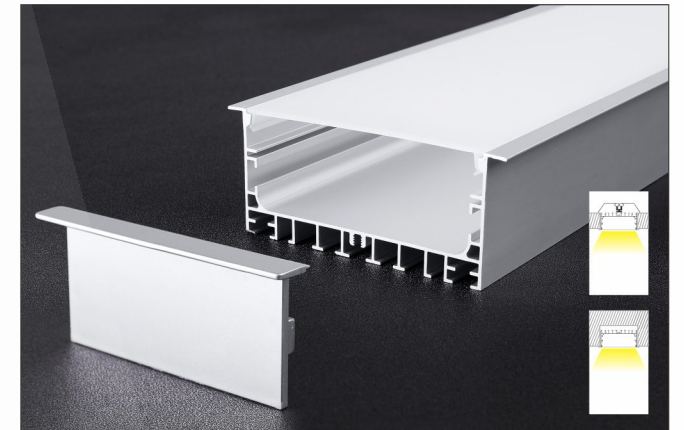
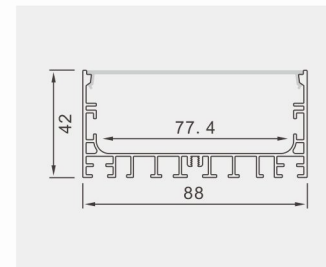

8842A

产品参数

尺寸: Lx100x42mm
材质: 6063-T5 铝合金
表面: 氧化铝本色/喷漆 (黑色/白色)
PC罩: 乳白/黑色/亚克力磨砂可选
适用: 70MM软灯带/硬灯条

Description

size: Lx100x42mm
Material: 6063-T5
Surface: Silver / black / white Anodized
PC cover: Milky white/black/acrylic matte
Apply: LED Strips and PCB 70mm

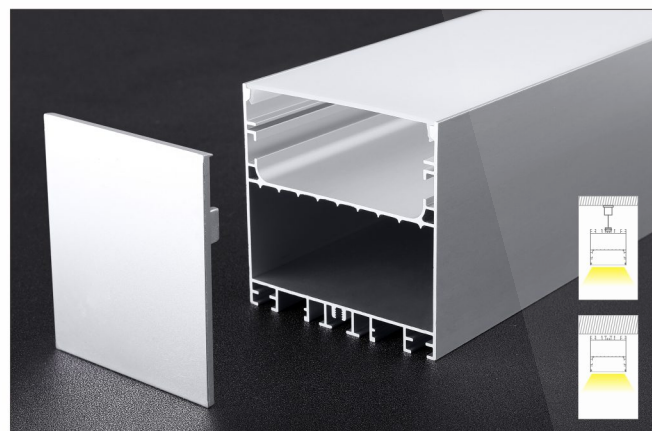
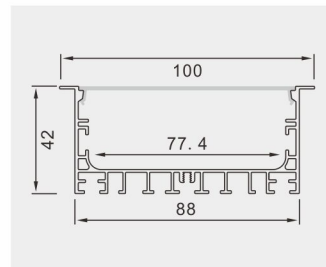

7878M

产品参数

尺寸: Lx78x78mm
材质: 6063-T5 铝合金
表面: 氧化铝本色/喷漆 (黑色/白色)
PC罩: 乳白/黑色/亚克力磨砂可选
适用: 60MM软灯带/硬灯条

Description

size: Lx78x78mm
Material: 6063-T5
Surface: Silver / black / white Anodized
PC cover: Milky white/black/acrylic matte
Apply: LED Strips and PCB 60mm

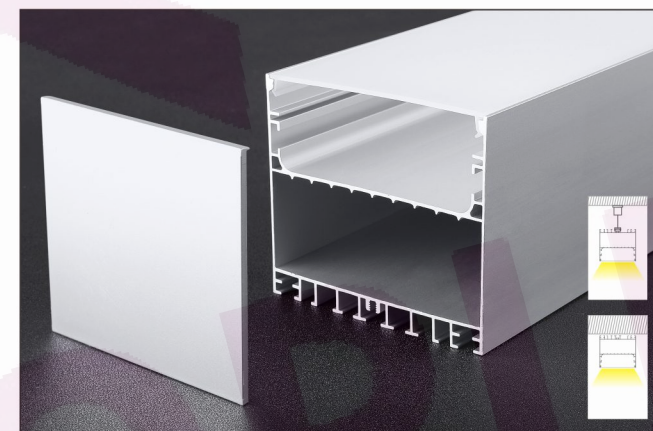
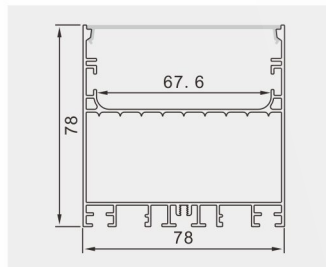

8878M

产品参数

尺寸: Lx88x78mm
材质: 6063-T5 铝合金
表面: 氧化铝本色/喷漆 (黑色/白色)
PC罩: 乳白/黑色/亚克力磨砂可选
适用: 70MM软灯带/硬灯条

Description

size: Lx88x78mm
Material: 6063-T5
Surface: Silver / black / white Anodized
PC cover: Milky white/black/acrylic matte
Apply: LED Strips and PCB 70mm

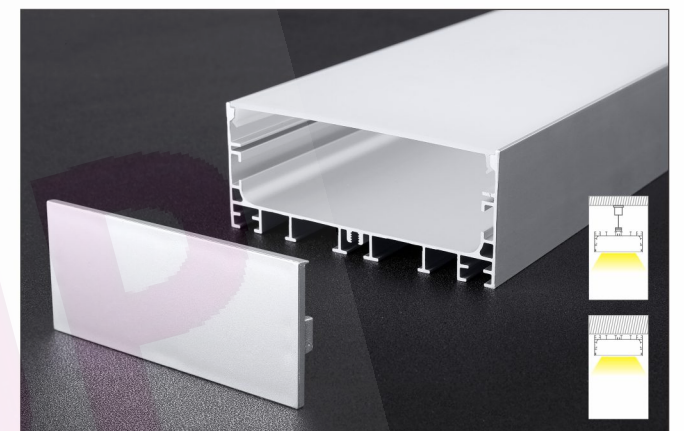
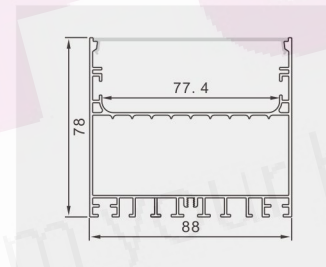

9842M

产品参数

尺寸: Lx98x42mm
材质: 6063-T5 铝合金
表面: 氧化铝本色/喷漆 (黑色/白色)
PC罩: 乳白/黑色/亚克力磨砂可选
适用: 80MM软灯带/硬灯条

Description

size: Lx98x42mm
Material: 6063-T5
Surface: Silver / black / white Anodized
PC cover: Milky white/black/acrylic matte
Apply: LED Strips and PCB 80mm

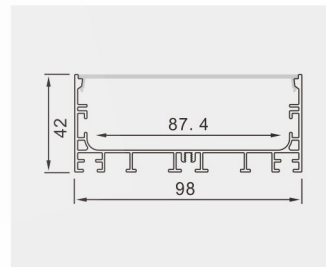

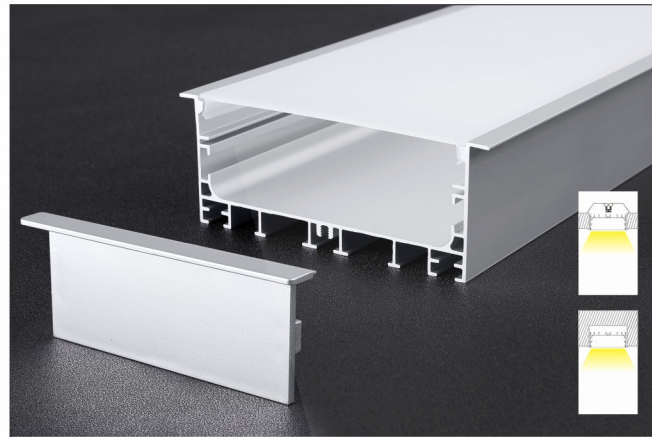

9842A

产品参数

尺寸: Lx110x42mm
材质: 6063-T5 铝合金
表面: 氧化铝本色/喷漆 (黑色/白色)
PC罩: 乳白/黑色/亚克力磨砂可选
适用: 80MM软灯带/硬灯条

Description

size: Lx110x42mm
Material: 6063-T5
Surface: Silver / black / white Anodized
PC cover: Milky white/black/acrylic matte
Apply: LED Strips and PCB 80mm

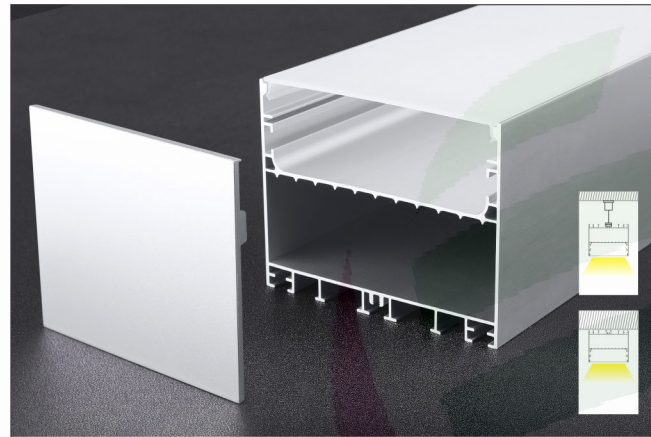
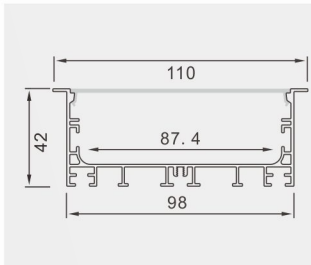

9878M

产品参数

尺寸: Lx98x78mm
材质: 6063-T5 铝合金
表面: 氧化铝本色/喷漆 (黑色/白色)
PC罩: 乳白/黑色/亚克力磨砂可选
适用: 80MM软灯带/硬灯条

Description

size: Lx98x78mm
Material: 6063-T5
Surface: Silver / black / white Anodized
PC cover: Milky white/black/acrylic matte
Apply: LED Strips and PCB 80mm

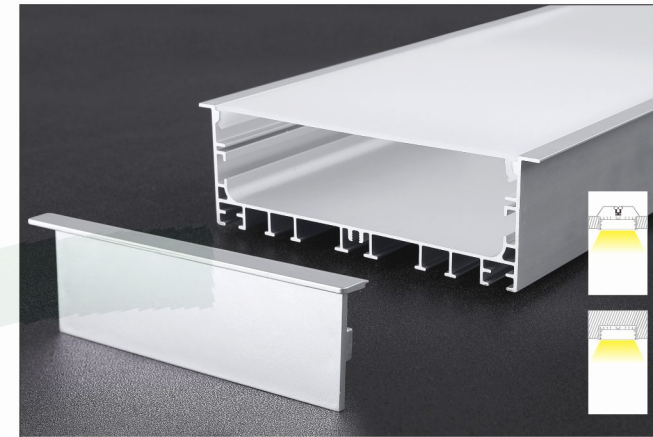
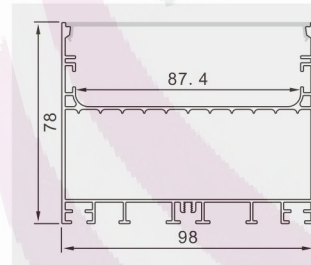

11842A

产品参数

尺寸: Lx130x42mm
材质: 6063-T5 铝合金
表面: 氧化铝本色/喷漆 (黑色/白色)
PC罩: 乳白/黑色/亚克力磨砂可选
适用: 100MM软灯带/硬灯条

Description

size: Lx130x42mm
Material: 6063-T5
Surface: Silver / black / white Anodized
PC cover: Milky white/black/acrylic matte
Apply: LED Strips and PCB 100mm

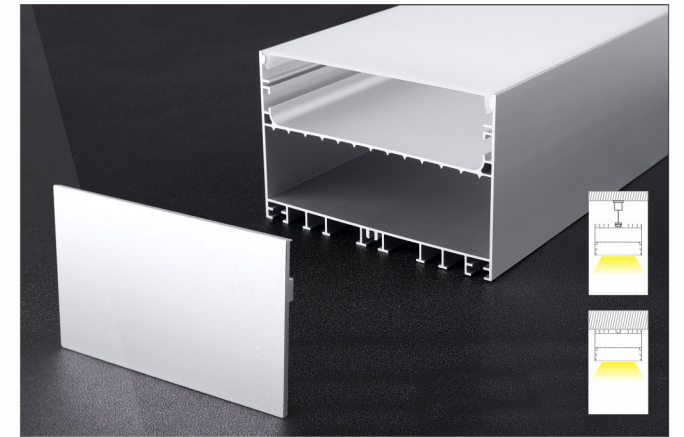
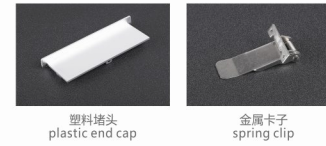
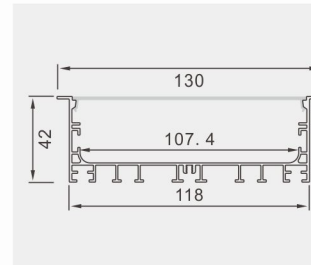

11878M

产品参数

尺寸: Lx118x78mm
材质: 6063-T5 铝合金
表面: 氧化铝本色/喷漆 (黑色/白色)
PC罩: 乳白/黑色/亚克力磨砂可选
适用: 100MM软灯带/硬灯条

Description

size: Lx118x78mm
Material: 6063-T5
Surface: Silver / black / white Anodized
PC cover: Milky white/black/acrylic matte
Apply: LED Strips and PCB 100mm

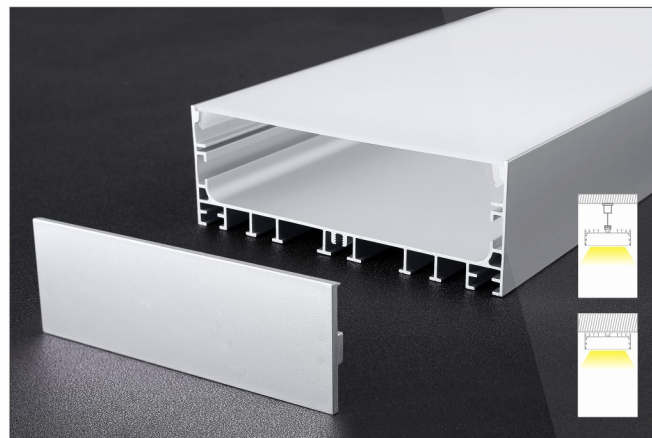
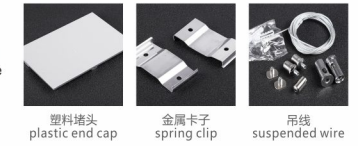
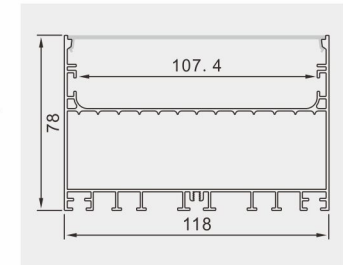

11842M

产品参数

尺寸: Lx118x42mm
材质: 6063-T5 铝合金
表面: 氧化铝本色/喷漆 (黑色/白色)
PC罩: 乳白/黑色/亚克力磨砂可选
适用: 100MM软灯带/硬灯条

Description

size: Lx118x42mm
Material: 6063-T5
Surface: Silver / black / white Anodized
PC cover: Milky white/black/acrylic matte
Apply: LED Strips and PCB 100mm

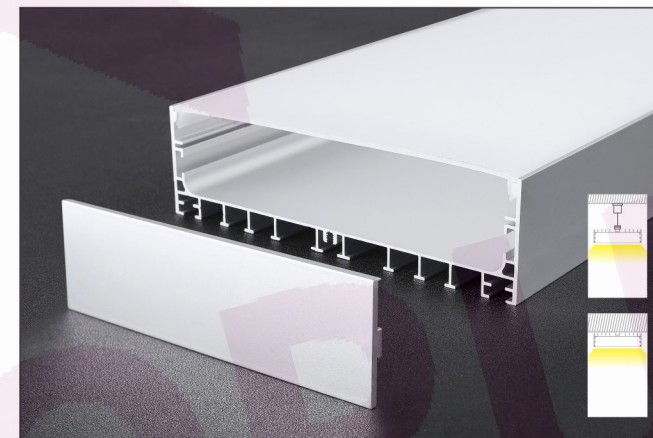
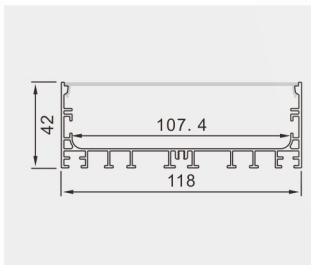

14842M

产品参数

尺寸: Lx148x42mm
材质: 6063-T5 铝合金
表面: 氧化铝本色/喷漆 (黑色/白色)
PC罩: 乳白/黑色/亚克力磨砂可选
适用: 120MM软灯带/硬灯条

Description

size: Lx148x42mm
Material: 6063-T5
Surface: Silver / black / white Anodized
PC cover: Milky white/black/acrylic matte
Apply: LED Strips and PCB 120mm

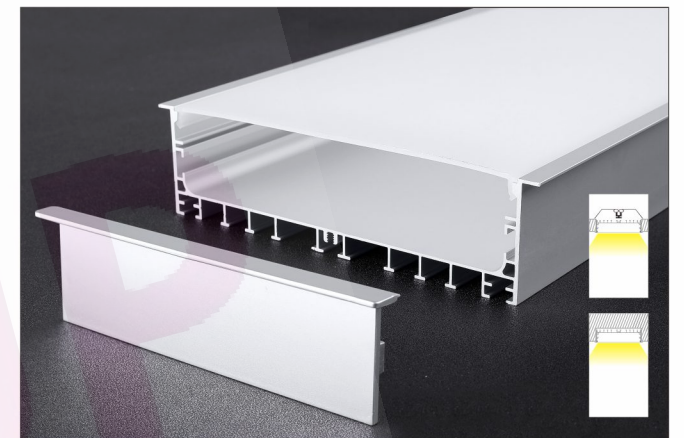
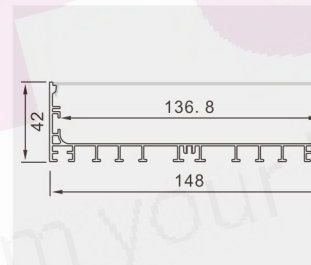

14842A

产品参数

尺寸: Lx160x42mm
材质: 6063-T5 铝合金
表面: 氧化铝本色/喷漆 (黑色/白色)
PC罩: 乳白/黑色/亚克力磨砂可选
适用: 120MM软灯带/硬灯条

Description

size: Lx160x42mm
Material: 6063-T5
Surface: Silver / black / white Anodized
PC cover: Milky white/black/acrylic matte
Apply: LED Strips and PCB 120mm

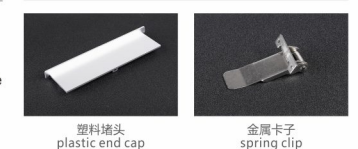
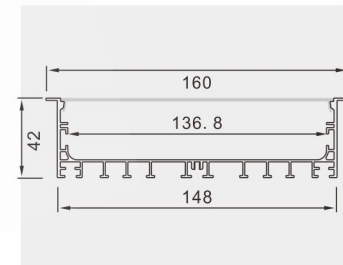

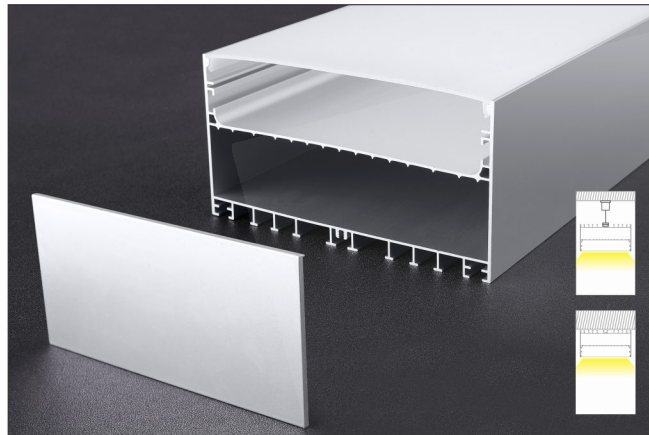

14878M

产品参数

尺寸: Lx148x78mm
材质: 6063-T5 铝合金
表面: 氧化铝本色/喷漆 (黑色/白色)
PC罩: 乳白/黑色/亚克力磨砂可选
适用: 120MM软灯带/硬灯条

Description

size: Lx148x78mm
Material: 6063-T5
Surface: Silver / black / white Anodized
PC cover: Milky white/black/acrylic matte
Apply: LED Strips and PCB 120mm

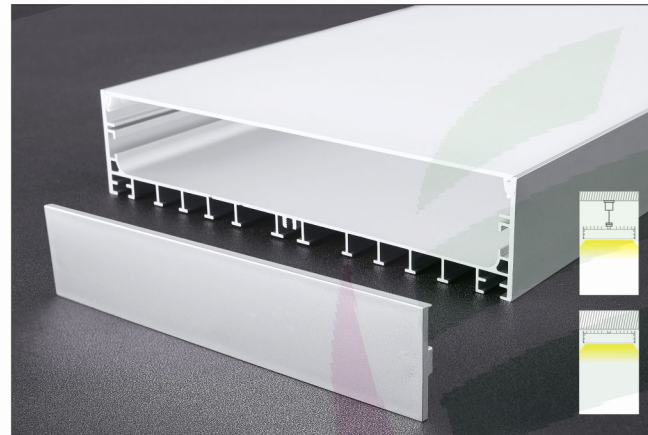
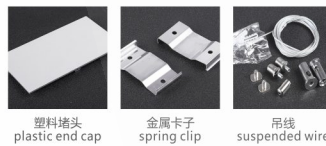
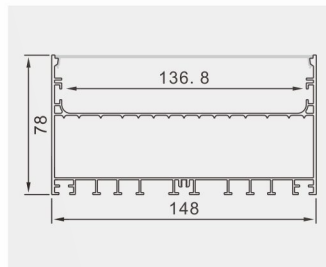

17842M

产品参数

尺寸: Lx178x42mm
材质: 6063-T5 铝合金
表面: 氧化铝本色/喷漆 (黑色/白色)
PC罩: 乳白/黑色/亚克力磨砂可选
适用: 150MM软灯带/硬灯条

Description

size: Lx178x42mm
Material: 6063-T5
Surface: Silver / black / white Anodized
PC cover: Milky white/black/acrylic matte
Apply: LED Strips and PCB 150mm

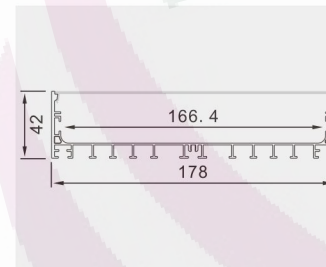

17842A

产品参数

尺寸: Lx190x42mm
材质: 6063-T5 铝合金
表面: 氧化铝本色/喷漆 (黑色/白色)
PC罩: 乳白/黑色/亚克力磨砂可选
适用: 150MM软灯带/硬灯条

Description

size: Lx190x42mm
Material: 6063-T5
Surface: Silver / black / white Anodized
PC cover: Milky white/black/acrylic matte
Apply: LED Strips and PCB 150mm

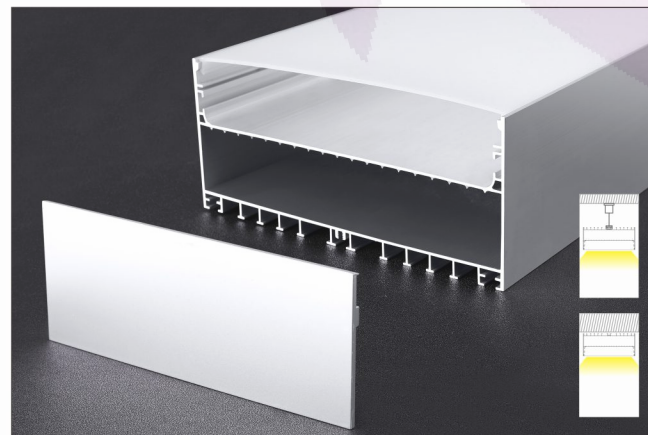
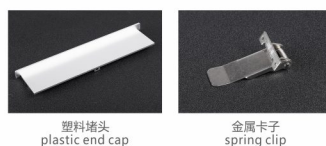
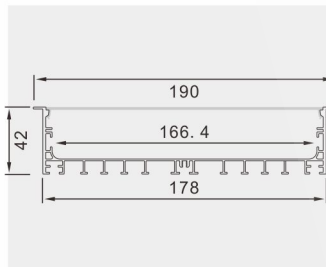

17878M

产品参数

尺寸: Lx178x78mm
材质: 6063-T5 铝合金
表面: 氧化铝本色/喷漆 (黑色/白色)
PC罩: 乳白/黑色/亚克力磨砂可选
适用: 150MM软灯带/硬灯条

Description

size: Lx178x78mm
Material: 6063-T5
Surface: Silver / black / white Anodized
PC cover: Milky white/black/acrylic matte
Apply: LED Strips and PCB 150mm

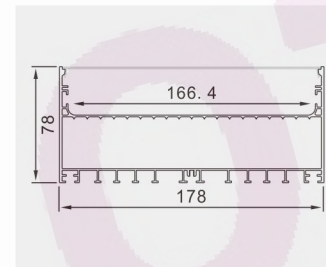

硬灯条 铝型材套件

»» P10-P22



2023
NEW STYLE

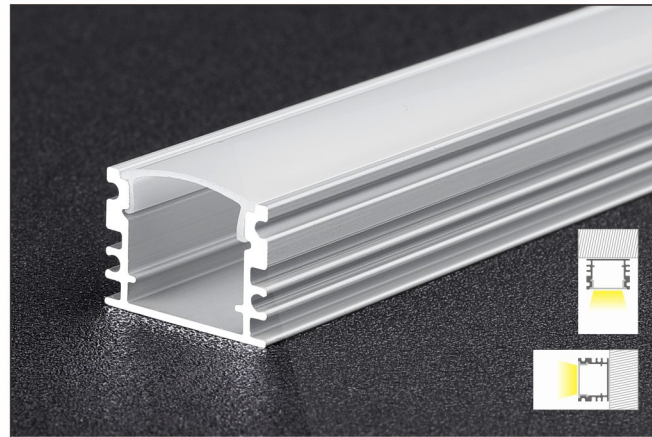

505

产品参数

尺寸: Lx17.2x12.1mm
材质: 6063-T5 铝合金
表面: 氧化铝本色/喷漆 (黑色/白色)
PC罩: 乳白/黑色/亚克力磨砂可选
适用: 10MM软灯带/硬灯条

Description

size: Lx17.2x12.1mm
Material: 6063-T5
Surface: Silver / black / white Anodized
PC cover: Milky white/black/acrylic matte
Apply: LED Strips and PCB 10mm

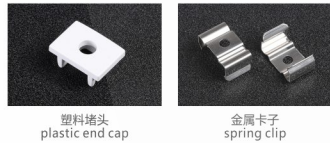
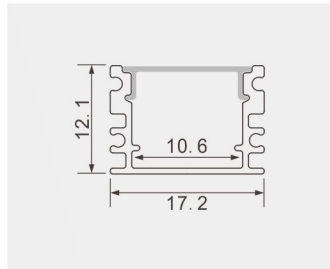

塑料堵头
plastic end cap

金属卡子
spring clip

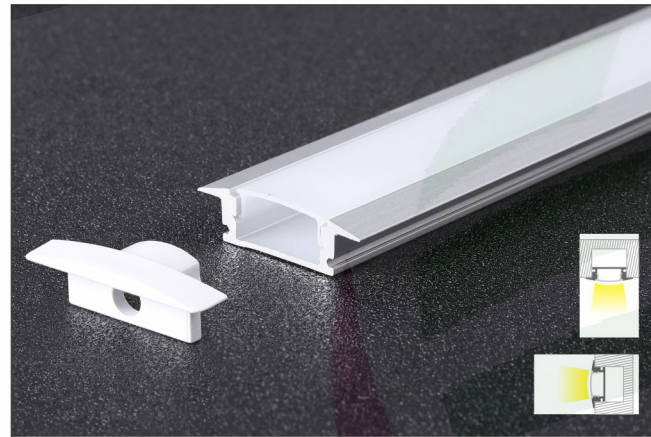

508

产品参数

尺寸: Lx24.7x7mm
材质: 6063-T5 铝合金
表面: 氧化铝本色/喷漆 (黑色/白色)
PC罩: 乳白/黑色/亚克力磨砂可选
适用: 12MM软灯带/硬灯条

Description

size: Lx24.7x7mm
Material: 6063-T5
Surface: Silver / black / white Anodized
PC cover: Milky white/black/acrylic matte
Apply: LED Strips and PCB 12mm

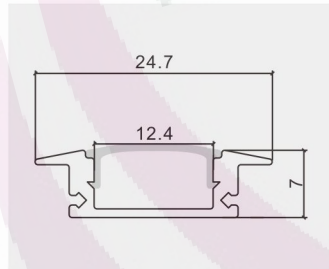

塑料堵头
plastic end cap

金属卡子
spring clip

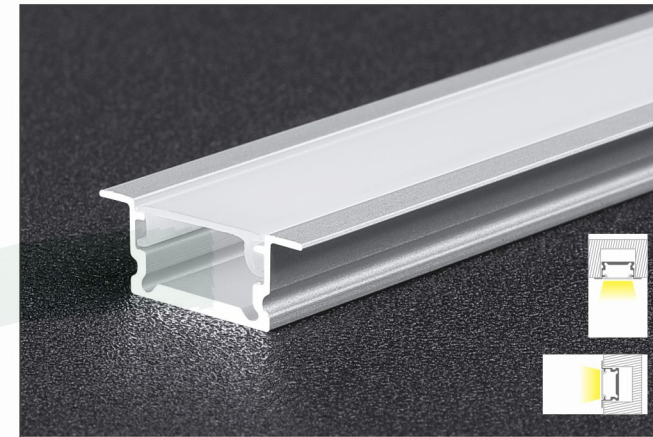

510A

产品参数

尺寸: Lx19.2x7mm
材质: 6063-T5 铝合金
表面: 氧化铝本色/喷漆 (黑色/白色)
PC罩: 乳白/黑色/亚克力磨砂可选
适用: 9MM软灯带/硬灯条

Description

size: Lx19.2x7mm
Material: 6063-T5
Surface: Silver / black / white Anodized
PC cover: Milky white/black/acrylic matte
Apply: LED Strips and PCB 9mm

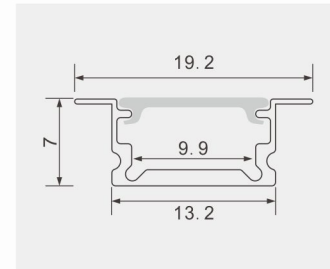

塑料堵头
plastic end cap

金属卡子
spring clip

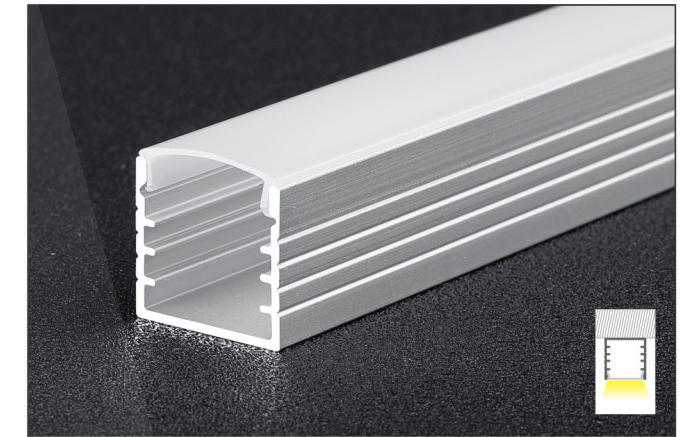

524

产品参数

尺寸: Lx14.6x14.5mm
材质: 6063-T5 铝合金
表面: 氧化铝本色/喷漆 (黑色/白色)
PC罩: 乳白/黑色/亚克力磨砂可选
适用: 13MM软灯带/硬灯条

Description

size: Lx14.6x14.5mm
Material: 6063-T5
Surface: Silver / black / white Anodized
PC cover: Milky white/black/acrylic matte
Apply: LED Strips and PCB 13mm

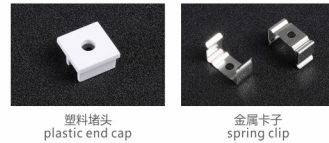
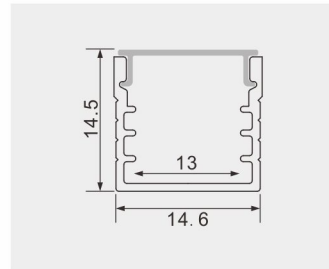

塑料堵头
plastic end cap

金属卡子
spring clip



509

产品参数

尺寸: Lx17.4x7mm
材质: 6063-T5 铝合金
表面: 氧化铝本色/喷漆 (黑色/白色)
PC罩: 乳白/黑色/亚克力磨砂可选
适用: 12MM软灯带/硬灯条

Description

size: Lx17.4x7mm
Material: 6063-T5
Surface: Silver / black / white Anodized
PC cover: Milky white/black/acrylic matte
Apply: LED Strips and PCB 12mm

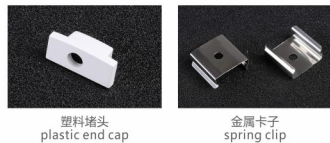
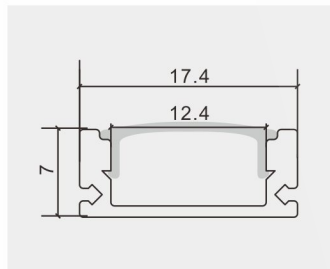

塑料堵头
plastic end cap

金属卡子
spring clip

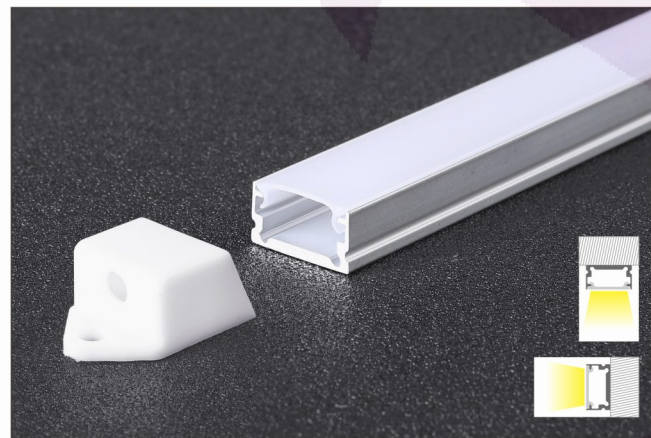

510

产品参数

尺寸: Lx13.2x7mm
材质: 6063-T5 铝合金
表面: 氧化铝本色/喷漆 (黑色/白色)
PC罩: 乳白/黑色/亚克力磨砂可选
适用: 12MM软灯带/硬灯条

Description

size: Lx13.2x7mm
Material: 6063-T5
Surface: Silver / black / white Anodized
PC cover: Milky white/black/acrylic matte
Apply: LED Strips and PCB 12mm

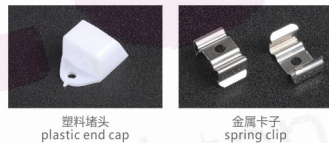
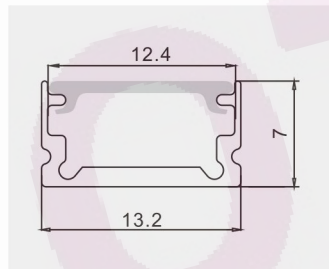

塑料堵头
plastic end cap

金属卡子
spring clip

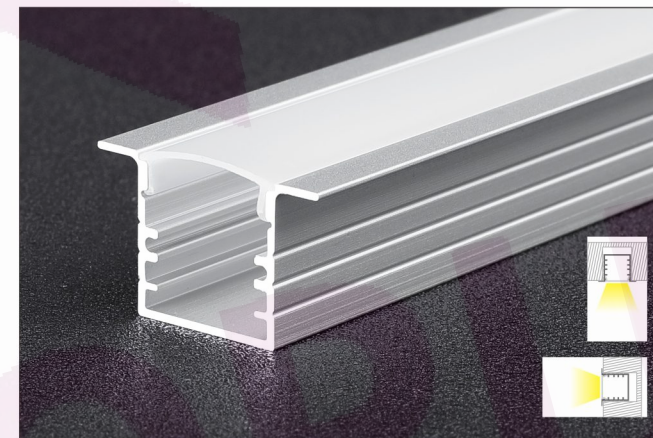

524A

产品参数

尺寸: Lx23.4x14.5mm
材质: 6063-T5 铝合金
表面: 氧化铝本色/喷漆 (黑色/白色)
PC罩: 乳白/黑色/亚克力磨砂可选
适用: 13MM软灯带/硬灯条

Description

size: Lx23.4x14.5mm
Material: 6063-T5
Surface: Silver / black / white Anodized
PC cover: Milky white/black/acrylic matte
Apply: LED Strips and PCB 13mm

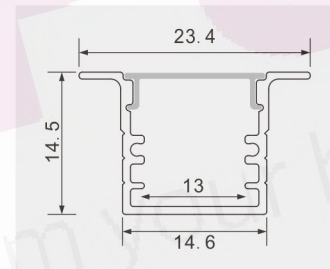

塑料堵头
plastic end cap

金属卡子
spring clip



601

产品参数

尺寸: Lx15.8x15.8mm
材质: 6063-T5 铝合金
表面: 氧化铝本色/喷漆 (黑色/白色)
PC罩: 乳白/黑色/亚克力磨砂可选
适用: 10MM软灯带/硬灯条

Description

size: Lx15.8x15.8mm
Material: 6063-T5
Surface: Silver / black / white Anodized
PC cover: Milky white/black/acrylic matte
Apply: LED Strips and PCB 10mm

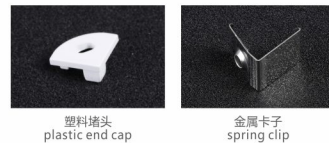
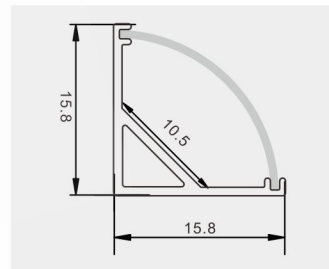

塑料堵头
plastic end cap

金属卡子
spring clip

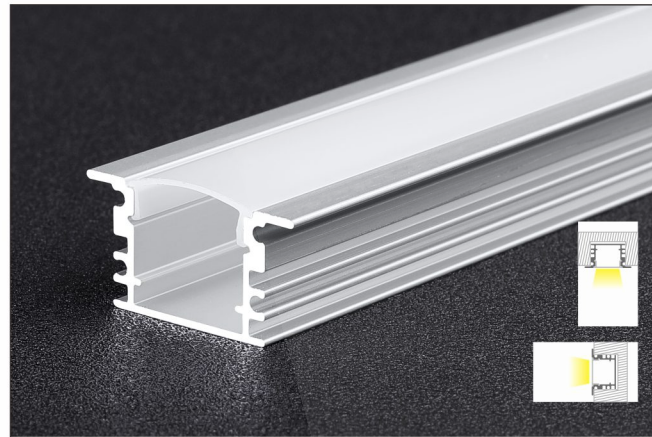

605

产品参数

尺寸: Lx23.5x12.1mm
材质: 6063-T5 铝合金
表面: 氧化铝本色/喷漆 (黑色/白色)
PC罩: 乳白/黑色/亚克力磨砂可选
适用: 10MM软灯带/硬灯条

Description

size: Lx23.5x12.1mm
Material: 6063-T5
Surface: Silver / black / white Anodized
PC cover: Milky white/black/acrylic matte
Apply: LED Strips and PCB 10mm

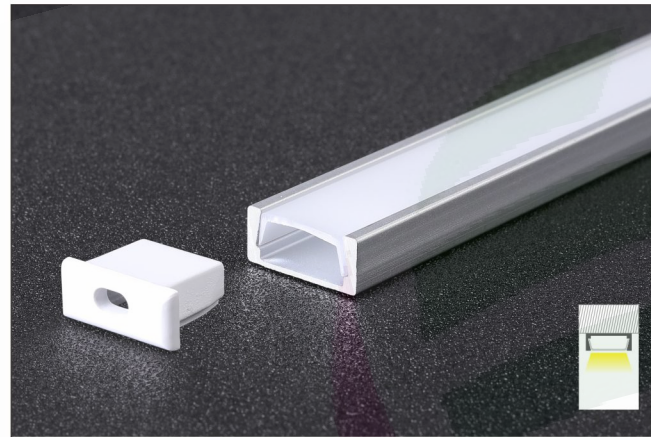
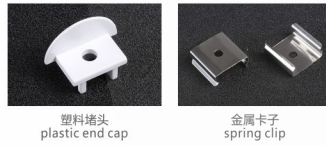
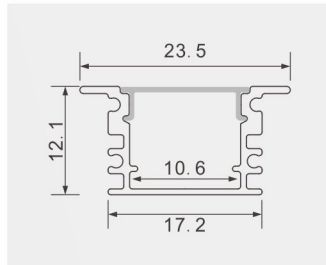

610

产品参数

尺寸: Lx15.5x5.9mm
材质: 6063-T5 铝合金
表面: 氧化铝本色/喷漆 (黑色/白色)
PC罩: 乳白/黑色/亚克力磨砂可选
适用: 12MM软灯带/硬灯条

Description

size: Lx15.5x5.9mm
Material: 6063-T5
Surface: Silver / black / white Anodized
PC cover: Milky white/black/acrylic matte
Apply: LED Strips and PCB 12mm

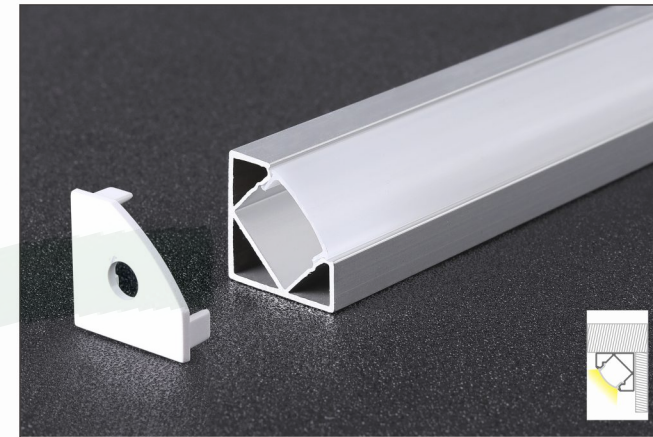
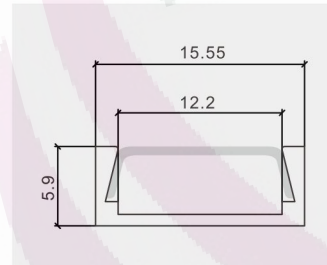

614

产品参数

尺寸: Lx19x19mm
材质: 6063-T5 铝合金
表面: 氧化铝本色/喷漆 (黑色/白色)
PC罩: 乳白/黑色/亚克力磨砂可选
适用: 12MM软灯带/硬灯条

Description

size: Lx19x19mm
Material: 6063-T5
Surface: Silver / black / white Anodized
PC cover: Milky white/black/acrylic matte
Apply: LED Strips and PCB 12mm

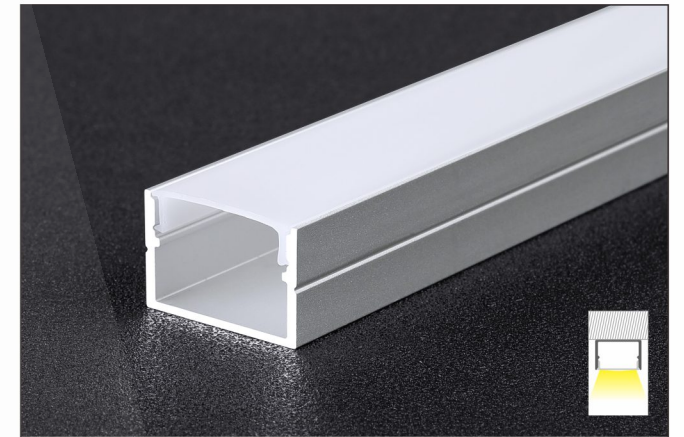
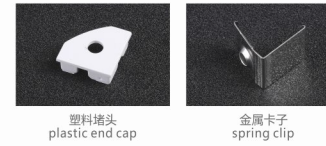
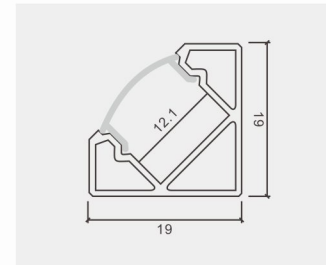

616

产品参数

尺寸: Lx20x13mm
材质: 6063-T5 铝合金
表面: 氧化铝本色/喷漆 (黑色/白色)
PC罩: 乳白/黑色/亚克力磨砂可选
适用: 17.6MM软灯带/硬灯条

Description

size: Lx20x13mm
Material: 6063-T5
Surface: Silver / black / white Anodized
PC cover: Milky white/black/acrylic matte
Apply: LED Strips and PCB 17.6mm

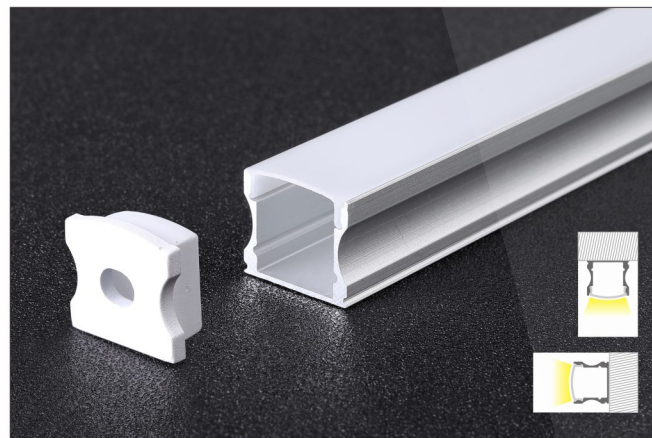
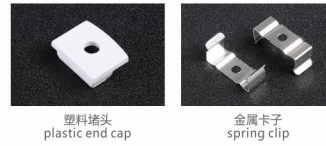
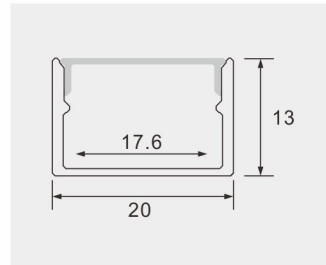

613

产品参数

尺寸: Lx17.2x14.4mm
材质: 6063-T5 铝合金
表面: 氧化铝本色/喷漆 (黑色/白色)
PC罩: 乳白/黑色/亚克力磨砂可选
适用: 12MM软灯带/硬灯条

Description

size: Lx17.2x14.4mm
Material: 6063-T5
Surface: Silver / black / white Anodized
PC cover: Milky white/black/acrylic matte
Apply: LED Strips and PCB 12mm

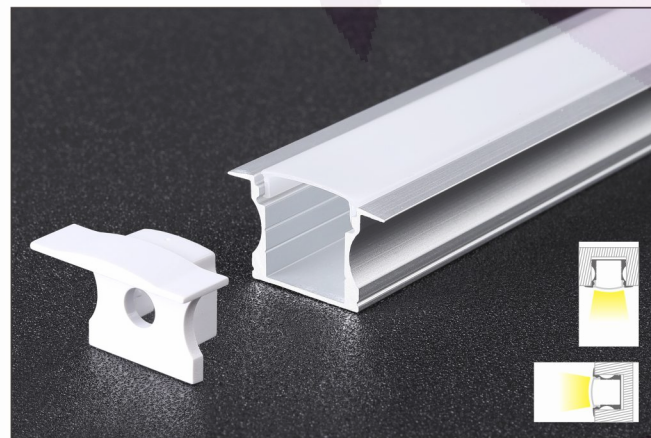
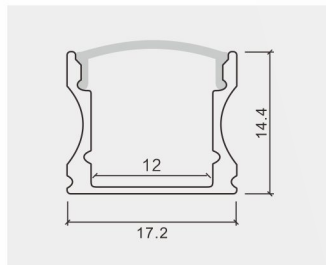

613B

产品参数

尺寸: Lx24x14.2mm
材质: 6063-T5 铝合金
表面: 氧化铝本色/喷漆 (黑色/白色)
PC罩: 乳白/黑色/亚克力磨砂可选
适用: 12MM软灯带/硬灯条

Description

size: Lx24x14.2mm
Material: 6063-T5
Surface: Silver / black / white Anodized
PC cover: Milky white/black/acrylic matte
Apply: LED Strips and PCB 12mm

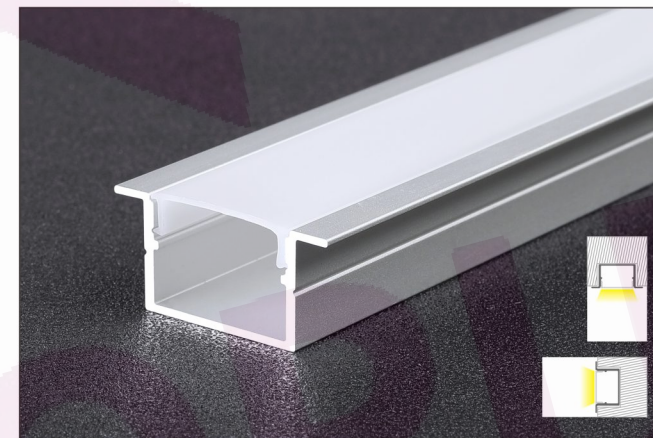
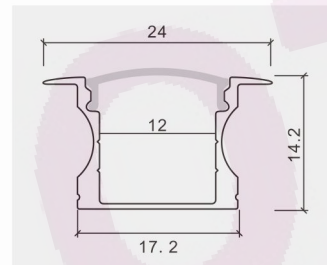

616A

产品参数

尺寸: Lx28x13mm
材质: 6063-T5 铝合金
表面: 氧化铝本色/喷漆 (黑色/白色)
PC罩: 乳白/黑色/亚克力磨砂可选
适用: 17.6MM软灯带/硬灯条

Description

size: Lx28x13mm
Material: 6063-T5
Surface: Silver / black / white Anodized
PC cover: Milky white/black/acrylic matte
Apply: LED Strips and PCB 17.6mm

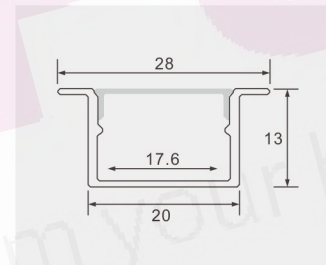

617

产品参数

尺寸: Lx23.5x9.8mm
材质: 6063-T5 铝合金
表面: 氧化铝本色/喷漆 (黑色/白色)
PC罩: 乳白/黑色/亚克力磨砂可选
适用: 21MM软灯带/硬灯条

Description

size: Lx23.5x9.8mm
Material: 6063-T5
Surface: Silver / black / white Anodized
PC cover: Milky white/black/acrylic matte
Apply: LED Strips and PCB 21mm

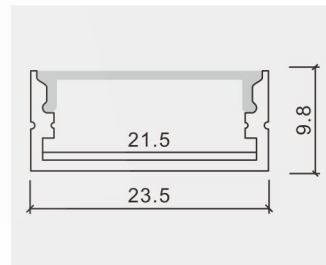

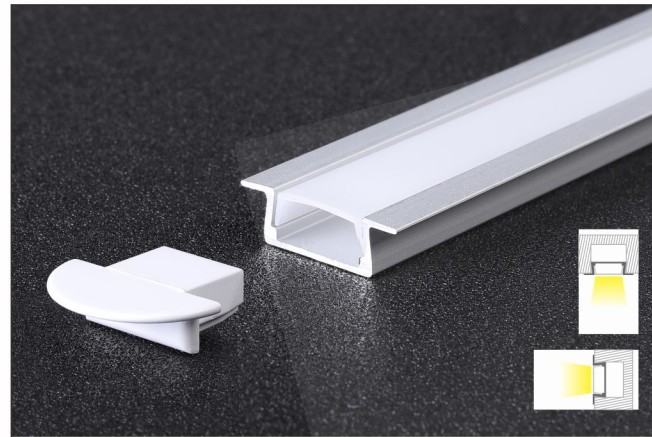

618

产品参数

尺寸: Lx21.7x5.7mm
材质: 6063-T5 铝合金
表面: 氧化铝本色/喷漆 (黑色/白色)
PC罩: 乳白/黑色/亚克力磨砂可选
适用: 11MM软灯带/硬灯条

Description

size: Lx21.7x5.7mm
Material: 6063-T5
Surface: Silver / black / white Anodized
PC cover: Milky white/black/acrylic matte
Apply: LED Strips and PCB 11mm

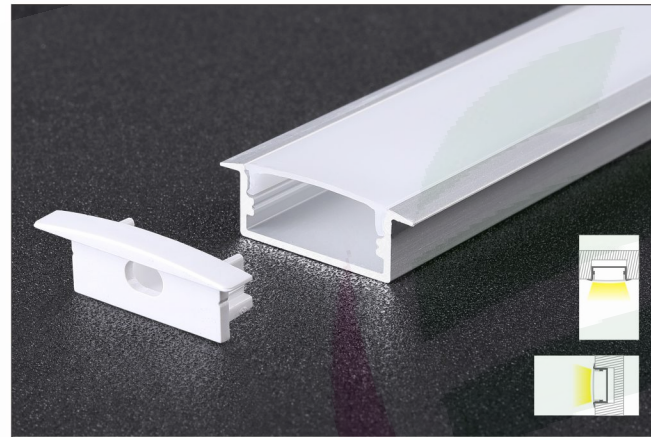
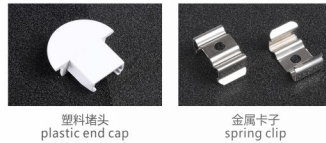
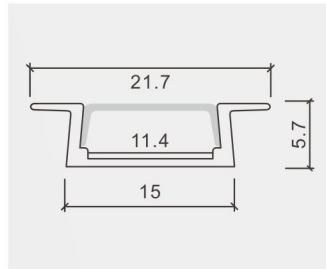

619

产品参数

尺寸: Lx30.3x9.8mm
材质: 6063-T5 铝合金
表面: 氧化铝本色/喷漆 (黑色/白色)
PC罩: 乳白/黑色/亚克力磨砂可选
适用: 21MM软灯带/硬灯条

Description

size: Lx30.3x9.8mm
Material: 6063-T5
Surface: Silver / black / white Anodized
PC cover: Milky white/black/acrylic matte
Apply: LED Strips and PCB 21mm

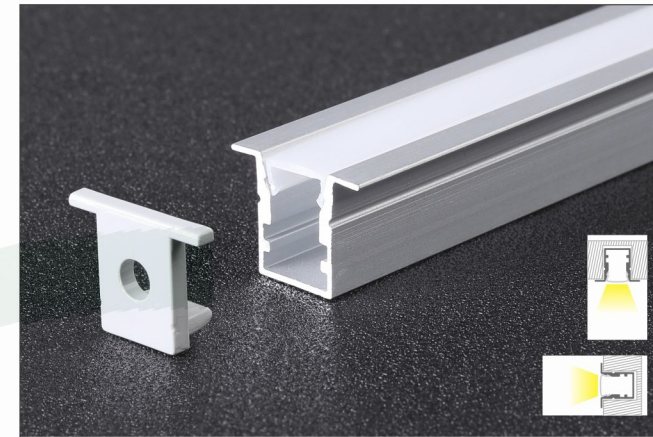
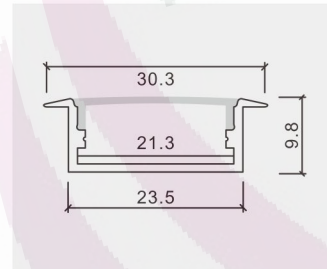

624A

产品参数

尺寸: Lx17x13mm
材质: 6063-T5 铝合金
表面: 氧化铝本色/喷漆 (黑色/白色)
PC罩: 乳白/黑色/亚克力磨砂可选
适用: 8MM软灯带/硬灯条

Description

size: Lx17x13mm
Material: 6063-T5
Surface: Silver / black / white Anodized
PC cover: Milky white/black/acrylic matte
Apply: LED Strips and PCB 8mm

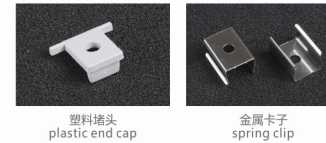
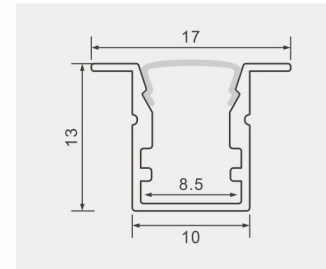

MA-1

产品参数

尺寸: Lx18.5x10.5mm
材质: 6063-T5 铝合金
表面: 氧化铝本色/喷漆 (黑色/白色)
PC罩: 乳白/黑色/亚克力磨砂可选
适用: 12MM软灯带/硬灯条

Description

size: Lx18.5x10.5mm
Material: 6063-T5
Surface: Silver / black / white Anodized
PC cover: Milky white/black/acrylic matte
Apply: LED Strips and PCB 12mm

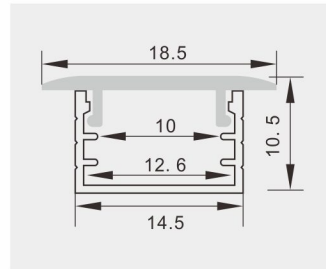

623

产品参数

尺寸: Lx20x20mm
材质: 6063-T5 铝合金
表面: 氧化铝本色/喷漆 (黑色/白色)
PC罩: 乳白/黑色/亚克力磨砂可选
适用: 16MM软灯带/硬灯条

Description

size: Lx20x20mm
Material: 6063-T5
Surface: Silver / black / white Anodized
PC cover: Milky white/black/acrylic matte
Apply: LED Strips and PCB 16mm

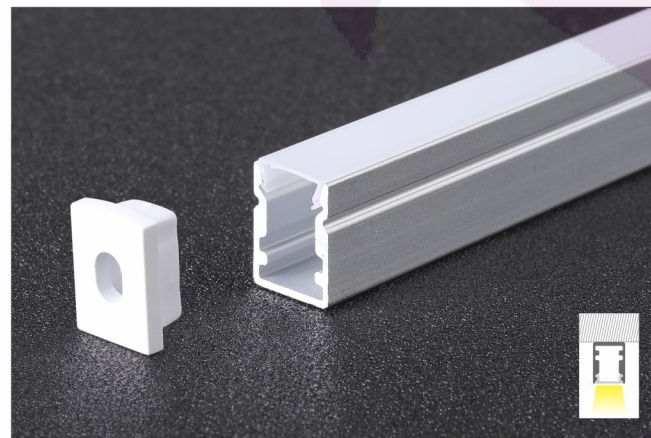
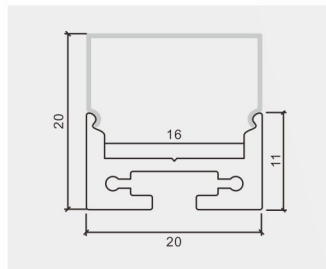

624

产品参数

尺寸: Lx10x13mm
材质: 6063-T5 铝合金
表面: 氧化铝本色/喷漆 (黑色/白色)
PC罩: 乳白/黑色/亚克力磨砂可选
适用: 8MM软灯带/硬灯条

Description

size: Lx10x13mm
Material: 6063-T5
Surface: Silver / black / white Anodized
PC cover: Milky white/black/acrylic matte
Apply: LED Strips and PCB 8mm

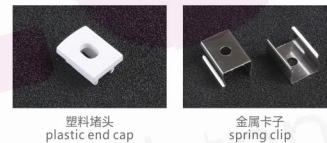
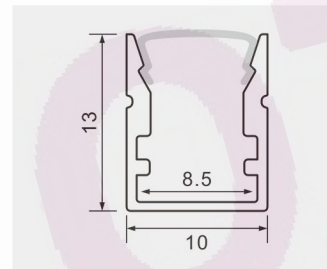

1409A

产品参数

尺寸: Lx18.6x8.5mm
材质: 6063-T5 铝合金
表面: 氧化铝本色/喷漆 (黑色/白色)
PC罩: 乳白/黑色/亚克力磨砂可选
适用: 12MM软灯带/硬灯条

Description

size: Lx18.6x8.5mm
Material: 6063-T5
Surface: Silver / black / white Anodized
PC cover: Milky white/black/acrylic matte
Apply: LED Strips and PCB 12mm

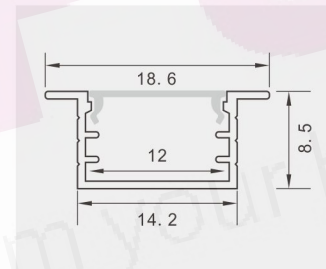

1409M

产品参数

尺寸: Lx14.2x8.5mm
材质: 6063-T5 铝合金
表面: 氧化铝本色/喷漆 (黑色/白色)
PC罩: 乳白/黑色/亚克力磨砂可选
适用: 12MM软灯带/硬灯条

Description

size: Lx14.2x8.5mm
Material: 6063-T5
Surface: Silver / black / white Anodized
PC cover: Milky white/black/acrylic matte
Apply: LED Strips and PCB 12mm

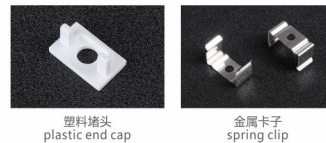
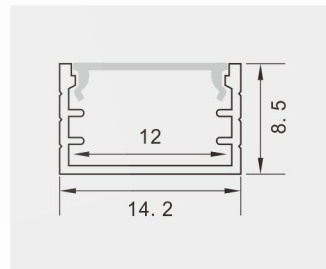

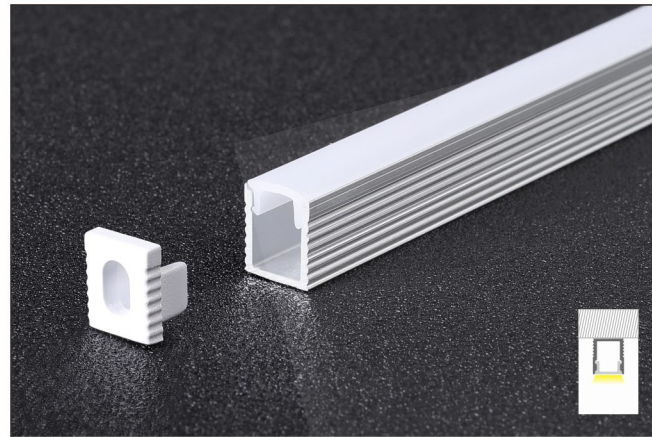

0809M

产品参数

尺寸: Lx7.8x9mm
材质: 6063-T5 铝合金
表面: 氧化铝本色/喷漆 (黑色/白色)
PC罩: 乳白/黑色/亚克力磨砂可选
适用: 5MM软灯带/硬灯条

Description

size: Lx7.8x9mm
Material: 6063-T5
Surface: Silver / black / white Anodized
PC cover: Milky white/black/acrylic matte
Apply: LED Strips and PCB 5mm

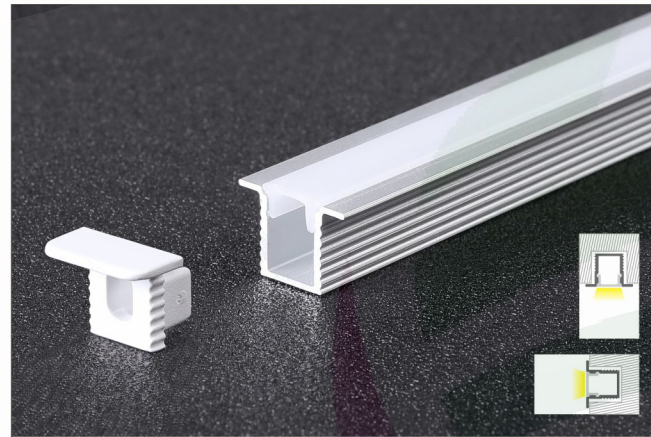
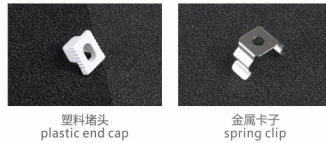
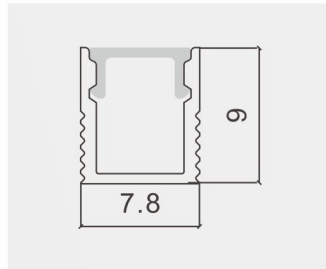

0809A

产品参数

尺寸: Lx12.8x9mm
材质: 6063-T5 铝合金
表面: 氧化铝本色/喷漆 (黑色/白色)
PC罩: 乳白/黑色/亚克力磨砂可选
适用: 5MM软灯带/硬灯条

Description

size: Lx12.8x9mm
Material: 6063-T5
Surface: Silver / black / white Anodized
PC cover: Milky white/black/acrylic matte
Apply: LED Strips and PCB 5mm

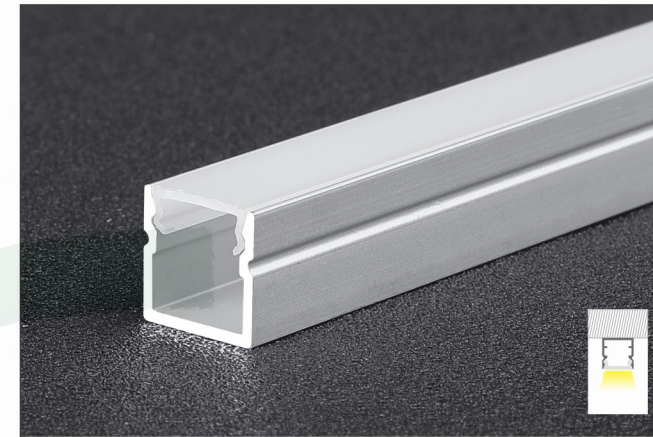
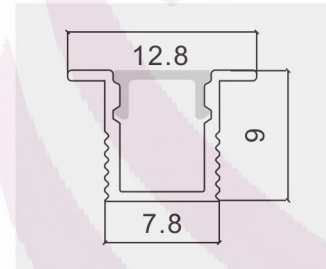

1010M-1

产品参数

尺寸: Lx10x10mm
材质: 6063-T5 铝合金
表面: 氧化铝本色/喷漆 (黑色/白色)
PC罩: 乳白/黑色/亚克力磨砂可选
适用: 8MM软灯带/硬灯条

Description

size: Lx10x10mm
Material: 6063-T5
Surface: Silver / black / white Anodized
PC cover: Milky white/black/acrylic matte
Apply: LED Strips and PCB 8mm

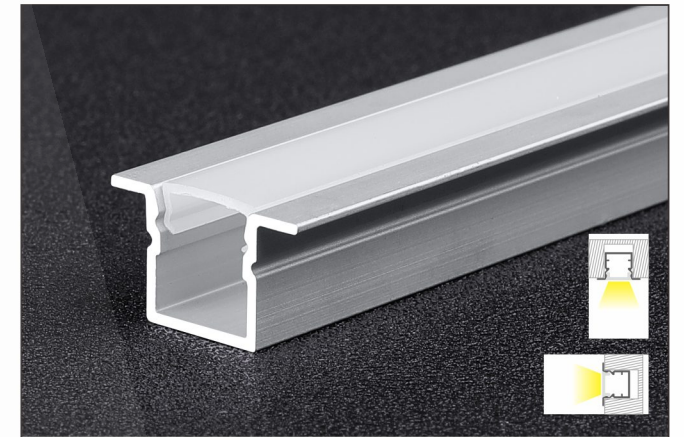
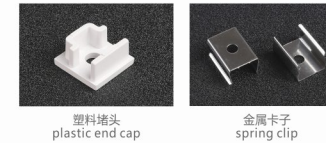
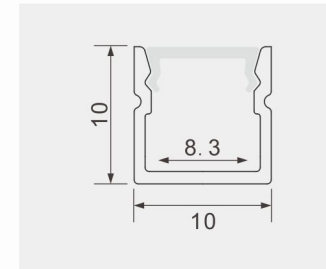

1010A-1

产品参数

尺寸: Lx15.6x10mm
材质: 6063-T5 铝合金
表面: 氧化铝本色/喷漆 (黑色/白色)
PC罩: 乳白/黑色/亚克力磨砂可选
适用: 8MM软灯带/硬灯条

Description

size: Lx15.6x10mm
Material: 6063-T5
Surface: Silver / black / white Anodized
PC cover: Milky white/black/acrylic matte
Apply: LED Strips and PCB 8mm

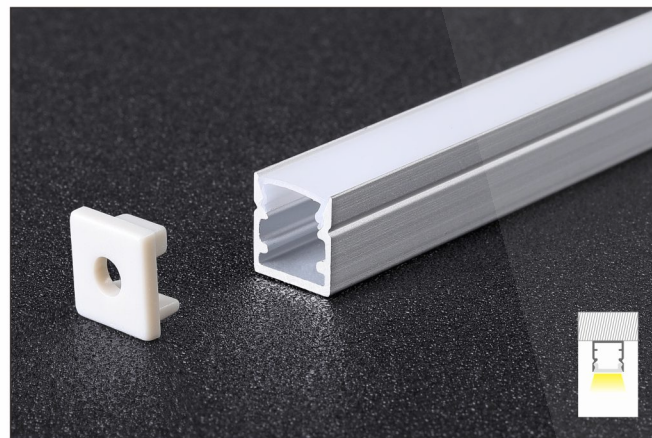
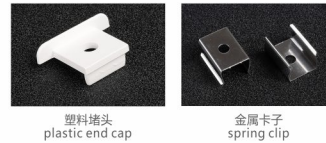
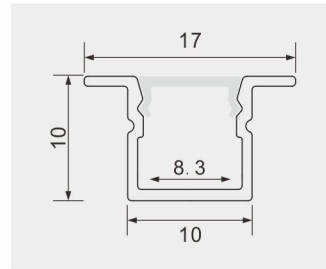

1010M

产品参数

尺寸: Lx10x10mm
材质: 6063-T5 铝合金
表面: 氧化铝本色/喷漆 (黑色/白色)
PC罩: 乳白/黑色/亚克力磨砂可选
适用: 8MM软灯带/硬灯条

Description

size: Lx10x10mm
Material: 6063-T5
Surface: Silver / black / white Anodized
PC cover: Milky white/black/acrylic matte
Apply: LED Strips and PCB 8mm

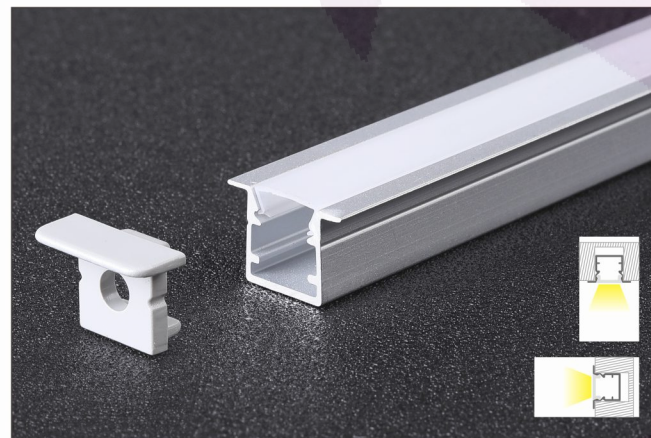
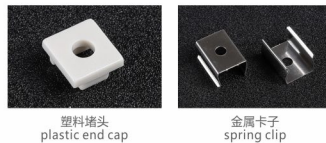
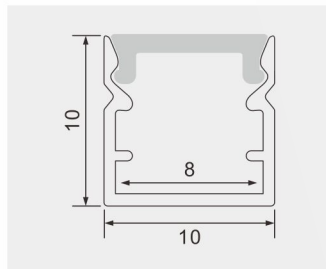

1010A

产品参数

尺寸: Lx15.6x10mm
材质: 6063-T5 铝合金
表面: 氧化铝本色/喷漆 (黑色/白色)
PC罩: 乳白/黑色/亚克力磨砂可选
适用: 8MM软灯带/硬灯条

Description

size: Lx15.6x10mm
Material: 6063-T5
Surface: Silver / black / white Anodized
PC cover: Milky white/black/acrylic matte
Apply: LED Strips and PCB 8mm

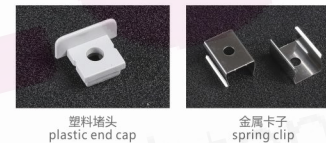
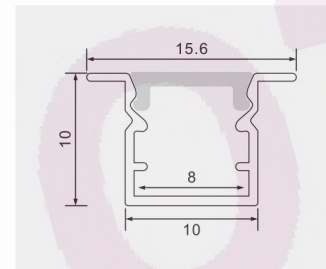

1313

产品参数

尺寸: Lx13x13mm
材质: 6063-T5 铝合金
表面: 氧化铝本色/喷漆 (黑色/白色)
PC罩: 乳白/黑色/亚克力磨砂可选
适用: 9.8MM软灯带/硬灯条

Description

size: Lx13x13mm
Material: 6063-T5
Surface: Silver / black / white Anodized
PC cover: Milky white/black/acrylic matte
Apply: LED Strips and PCB 9.8mm

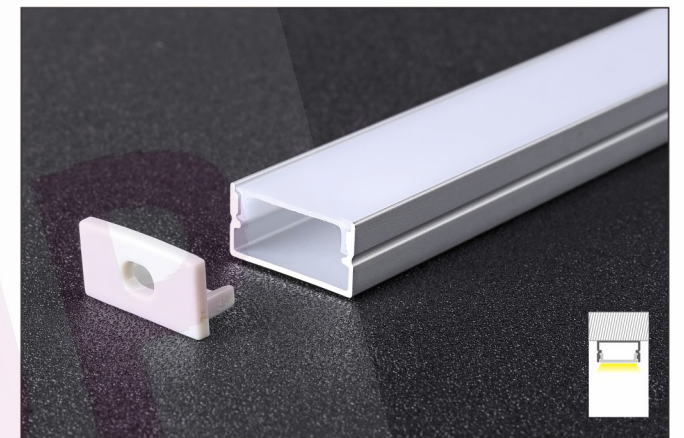
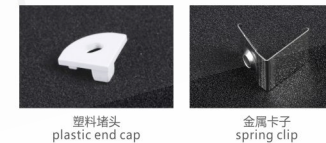
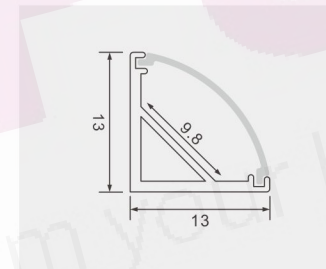

2010M

产品参数

尺寸: Lx20x10mm
材质: 6063-T5 铝合金
表面: 氧化铝本色/喷漆 (黑色/白色)
PC罩: 乳白/黑色/亚克力磨砂可选
适用: 18MM软灯带/硬灯条

Description

size: Lx20x10mm
Material: 6063-T5
Surface: Silver / black / white Anodized
PC cover: Milky white/black/acrylic matte
Apply: LED Strips and PCB 18mm

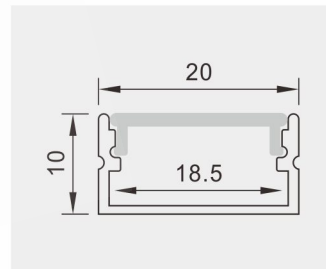



2010A

产品参数
尺寸: Lx28x10mm
材质: 6063-T5 铝合金
表面: 氧化铝本色/喷漆 (黑色/白色)
PC罩: 乳白/黑色/亚克力磨砂可选
适用: 18MM软灯带/硬灯条

Description
size: Lx28x10mm
Material: 6063-T5
Surface: Silver / black / white Anodized
PC cover: Milky white/black/acrylic matte
Apply: LED Strips and PCB 18mm



塑料堵头 plastic end cap 金属卡子 spring clip



2010M加厚款

产品参数
尺寸: Lx20x10mm
材质: 6063-T5 铝合金
表面: 氧化铝本色/喷漆 (黑色/白色)
PC罩: 乳白/黑色/亚克力磨砂可选
适用: 18MM软灯带/硬灯条

Description
size: Lx20x10mm
Material: 6063-T5
Surface: Silver / black / white Anodized
PC cover: Milky white/black/acrylic matte
Apply: LED Strips and PCB 18mm



塑料堵头 plastic end cap 金属卡子 spring clip



2020M

产品参数
尺寸: Lx20x20mm
材质: 6063-T5 铝合金
表面: 氧化铝本色/喷漆 (黑色/白色)
PC罩: 乳白/黑色/亚克力磨砂可选
适用: 18MM软灯带/硬灯条

Description
size: Lx20x20mm
Material: 6063-T5
Surface: Silver / black / white Anodized
PC cover: Milky white/black/acrylic matte
Apply: LED Strips and PCB 18mm



塑料堵头 plastic end cap 金属卡子 spring clip



2020A

产品参数
尺寸: Lx28x20mm
材质: 6063-T5 铝合金
表面: 氧化铝本色/喷漆 (黑色/白色)
PC罩: 乳白/黑色/亚克力磨砂可选
适用: 17MM软灯带/硬灯条

Description
size: Lx28x20mm
Material: 6063-T5
Surface: Silver / black / white Anodized
PC cover: Milky white/black/acrylic matte
Apply: LED Strips and PCB 17mm



塑料堵头 plastic end cap 金属卡子 spring clip



2010A加厚款

产品参数
尺寸: Lx28x10mm
材质: 6063-T5 铝合金
表面: 氧化铝本色/喷漆 (黑色/白色)
PC罩: 乳白/黑色/亚克力磨砂可选
适用: 18MM软灯带/硬灯条

Description
size: Lx28x10mm
Material: 6063-T5
Surface: Silver / black / white Anodized
PC cover: Milky white/black/acrylic matte
Apply: LED Strips and PCB 18mm



塑料堵头 plastic end cap 金属卡子 spring clip



2011

产品参数
尺寸: Lx20x20mm
材质: 6063-T5 铝合金
表面: 氧化铝本色/喷漆 (黑色/白色)
PC罩: 乳白/黑色/亚克力磨砂可选
适用: 16MM软灯带/硬灯条

Description
size: Lx20x20mm
Material: 6063-T5
Surface: Silver / black / white Anodized
PC cover: Milky white/black/acrylic matte
Apply: LED Strips and PCB 16mm



塑料堵头 plastic end cap 金属卡子 spring clip



2020M加厚款

产品参数
尺寸: Lx20x20mm
材质: 6063-T5 铝合金
表面: 氧化铝本色/喷漆 (黑色/白色)
PC罩: 乳白/黑色/亚克力磨砂可选
适用: 18MM软灯带/硬灯条

Description
size: Lx20x20mm
Material: 6063-T5
Surface: Silver / black / white Anodized
PC cover: Milky white/black/acrylic matte
Apply: LED Strips and PCB 18mm



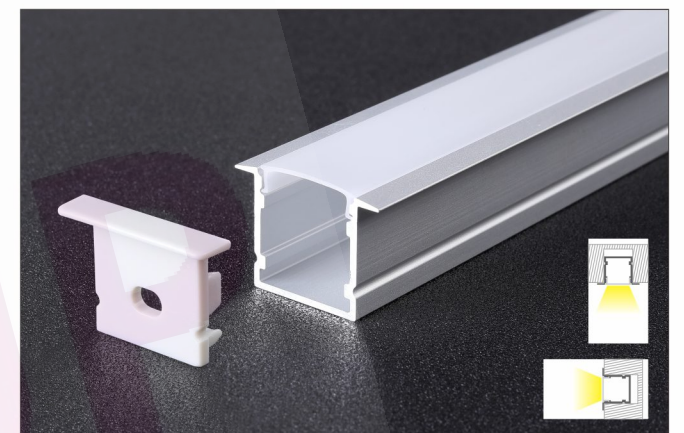

塑料堵头 plastic end cap 金属卡子 spring clip



2020A加厚款

产品参数
尺寸: Lx28x20mm
材质: 6063-T5 铝合金
表面: 氧化铝本色/喷漆 (黑色/白色)
PC罩: 乳白/黑色/亚克力磨砂可选
适用: 17MM软灯带/硬灯条

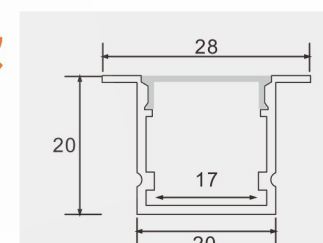
Description
size: Lx28x20mm
Material: 6063-T5
Surface: Silver / black / white Anodized
PC cover: Milky white/black/acrylic matte
Apply: LED Strips and PCB 17mm



塑料堵头 plastic end cap 金属卡子 spring clip



2320M

产品参数
尺寸: Lx23x20mm
材质: 6063-T5 铝合金
表面: 氧化铝本色/喷漆 (黑色/白色)
PC罩: 乳白/黑色/亚克力磨砂可选
适用: 20MM软灯带/硬灯条

Description
size: Lx23x20mm
Material: 6063-T5
Surface: Silver / black / white Anodized
PC cover: Milky white/black/acrylic matte
Apply: LED Strips and PCB 20mm



塑料堵头 plastic end cap 金属卡子 spring clip



2320A

产品参数
尺寸: Lx32x20mm
材质: 6063-T5 铝合金
表面: 氧化铝本色/喷漆 (黑色/白色)
PC罩: 乳白/黑色/亚克力磨砂可选
适用: 20MM软灯带/硬灯条

Description
size: Lx32x20mm
Material: 6063-T5
Surface: Silver / black / white Anodized
PC cover: Milky white/black/acrylic matte
Apply: LED Strips and PCB 20mm



塑料堵头 plastic end cap 金属卡子 spring clip



3020M

产品参数
尺寸: Lx30x20mm
材质: 6063-T5 铝合金
表面: 氧化铝本色/喷漆 (黑色/白色)
PC罩: 乳白/黑色/亚克力磨砂可选
适用: 26MM软灯带/硬灯条

Description
size: Lx30x20mm
Material: 6063-T5
Surface: Silver / black / white Anodized
PC cover: Milky white/black/acrylic matte
Apply: LED Strips and PCB 26mm



塑料堵头 plastic end cap 金属卡子 spring clip



3020A

产品参数
尺寸: Lx44x20mm
材质: 6063-T5 铝合金
表面: 氧化铝本色/喷漆 (黑色/白色)
PC罩: 乳白/黑色/亚克力磨砂可选
适用: 27MM软灯带/硬灯条

Description
size: Lx44x20mm
Material: 6063-T5
Surface: Silver / black / white Anodized
PC cover: Milky white/black/acrylic matte
Apply: LED Strips and PCB 27mm



塑料堵头 plastic end cap 金属卡子 spring clip



3010M

产品参数
尺寸: Lx30x10mm
材质: 6063-T5 铝合金
表面: 氧化铝本色/喷漆 (黑色/白色)
PC罩: 乳白/黑色/亚克力磨砂可选
适用: 27MM软灯带/硬灯条

Description
size: Lx30x10mm
Material: 6063-T5
Surface: Silver / black / white Anodized
PC cover: Milky white/black/acrylic matte
Apply: LED Strips and PCB 27mm



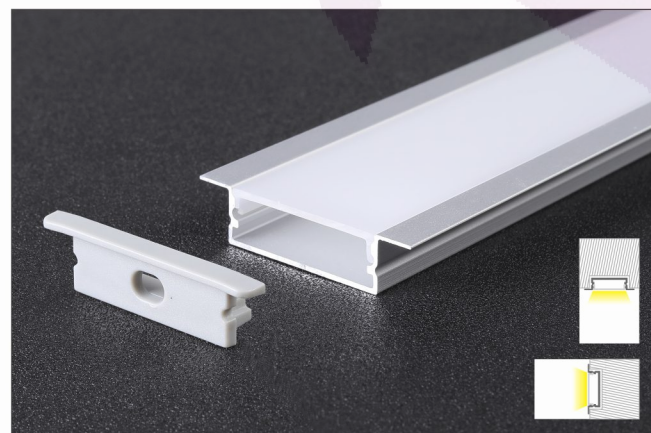

塑料堵头 plastic end cap 金属卡子 spring clip



3010A

产品参数
尺寸: Lx41x10mm
材质: 6063-T5 铝合金
表面: 氧化铝本色/喷漆 (黑色/白色)
PC罩: 乳白/黑色/亚克力磨砂可选
适用: 27MM软灯带/硬灯条

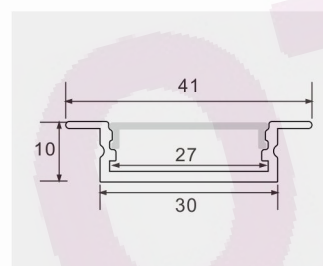
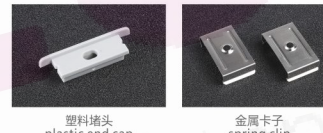
Description
size: Lx41x10mm
Material: 6063-T5
Surface: Silver / black / white Anodized
PC cover: Milky white/black/acrylic matte
Apply: LED Strips and PCB 27mm

塑料堵头 plastic end cap 金属卡子 spring clip



3030M

产品参数
尺寸: Lx30x30mm
材质: 6063-T5 铝合金
表面: 氧化铝本色/喷漆 (黑色/白色)
PC罩: 乳白/黑色/亚克力磨砂可选
适用: 25MM软灯带/硬灯条

Description
size: Lx30x30mm
Material: 6063-T5
Surface: Silver / black / white Anodized
PC cover: Milky white/black/acrylic matte
Apply: LED Strips and PCB 25mm



金属堵头 metal end cap 金属卡子 spring clip 吊线 suspended wire



3030A

产品参数
尺寸: Lx45x30mm
材质: 6063-T5 铝合金
表面: 氧化铝本色/喷漆 (黑色/白色)
PC罩: 乳白/黑色/亚克力磨砂可选
适用: 25MM软灯带/硬灯条

Description
size: Lx45x30mm
Material: 6063-T5
Surface: Silver / black / white Anodized
PC cover: Milky white/black/acrylic matte
Apply: LED Strips and PCB 25mm





塑料堵头 plastic end cap 金属卡子 spring clip

线条灯 (办公灯系列)

铝型材套件

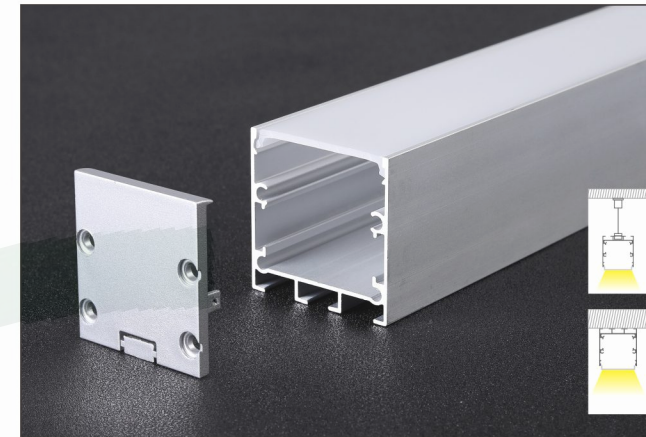
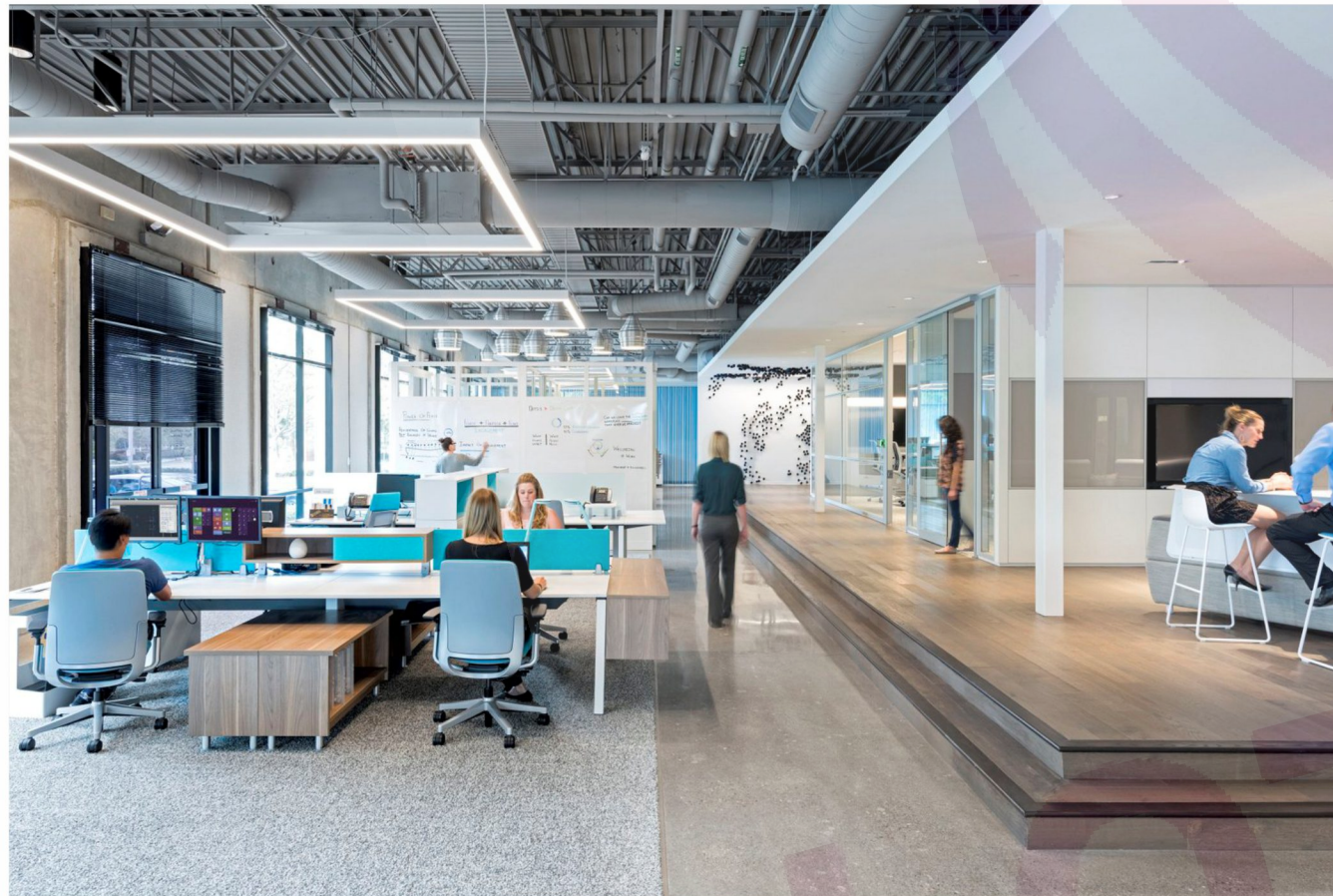
»» P23-P38



3535M

产品参数

尺寸: Lx35x35mm
材质: 6063-T5 铝合金
表面: 氧化铝本色/喷漆 (黑色/白色)
PC罩: 乳白/黑色/亚克力磨砂可选
适用: 29MM软灯带/硬灯条

Description

size: Lx35x35mm
Material: 6063-T5
Surface: Silver / black / white Anodized
PC cover: Milky white/black/acrylic matte
Apply: LED Strips and PCB 29mm

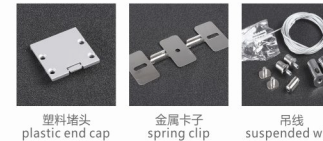
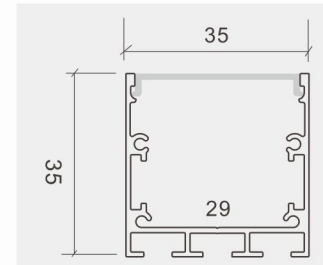

塑料堵头 plastic end cap 金属卡子 spring clip 吊线 suspended wire

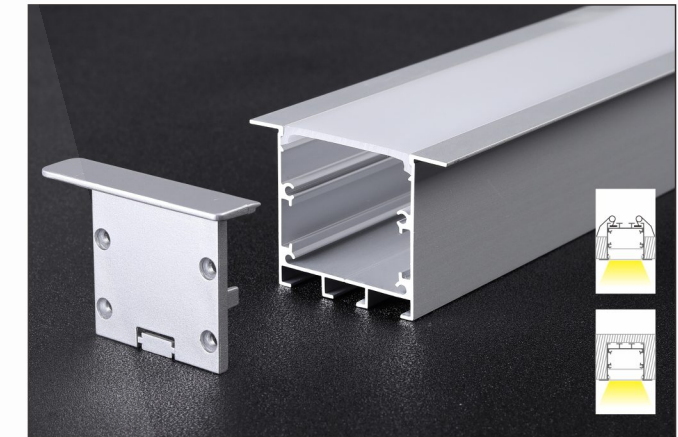

3535A

产品参数

尺寸: Lx50x35mm
材质: 6063-T5 铝合金
表面: 氧化铝本色/喷漆 (黑色/白色)
PC罩: 乳白/黑色/亚克力磨砂可选
适用: 29MM软灯带/硬灯条

Description

size: Lx50x35mm
Material: 6063-T5
Surface: Silver / black / white Anodized
PC cover: Milky white/black/acrylic matte
Apply: LED Strips and PCB 29mm

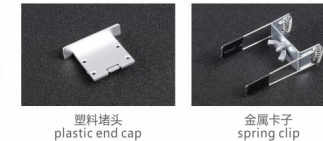
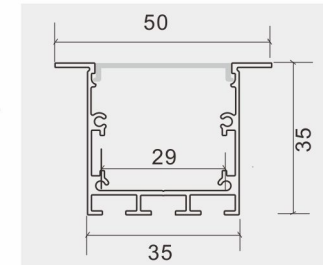

塑料堵头 plastic end cap 金属卡子 spring clip



4020M

产品参数

尺寸: Lx40x20mm
材质: 6063-T5 铝合金
表面: 氧化铝本色/喷漆 (黑色/白色)
PC罩: 乳白/黑色/亚克力磨砂可选
适用: 38MM软灯带/硬灯条

Description

size: Lx40x20mm
Material: 6063-T5
Surface: Silver / black / white Anodized
PC cover: Milky white/black/acrylic matte
Apply: LED Strips and PCB 38mm

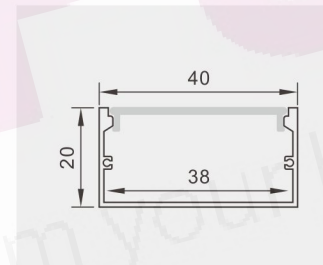

塑料堵头 plastic end cap



4020A

产品参数

尺寸: Lx55x20mm
材质: 6063-T5 铝合金
表面: 氧化铝本色/喷漆 (黑色/白色)
PC罩: 乳白/黑色/亚克力磨砂可选
适用: 38MM软灯带/硬灯条

Description

size: Lx55x20mm
Material: 6063-T5
Surface: Silver / black / white Anodized
PC cover: Milky white/black/acrylic matte
Apply: LED Strips and PCB 38mm

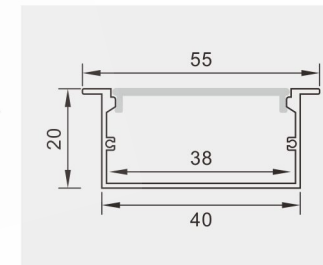

塑料堵头 plastic end cap

2023
NEW STYLE

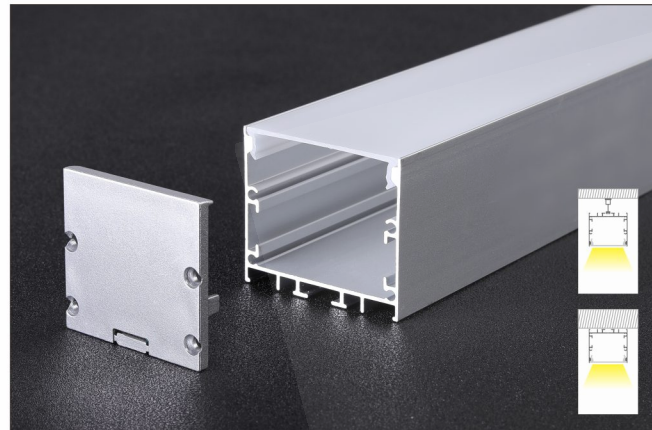

4035M

产品参数

尺寸: Lx40x35mm
材质: 6063-T5 铝合金
表面: 氧化铝本色/喷漆 (黑色/白色)
PC罩: 乳白/黑色/亚克力磨砂可选
适用: 32MM软灯带/硬灯条

Description

size: Lx40x35mm
Material: 6063-T5
Surface: Silver / black / white Anodized
PC cover: Milky white/black/acrylic matte
Apply: LED Strips and PCB 32mm

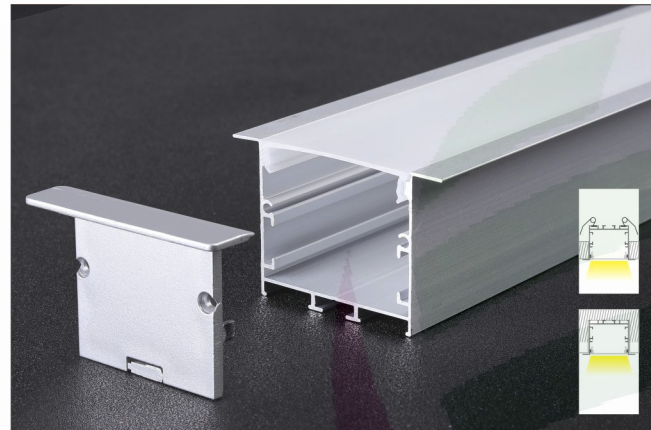
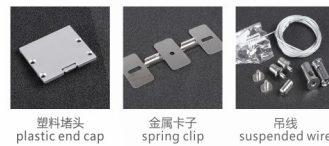
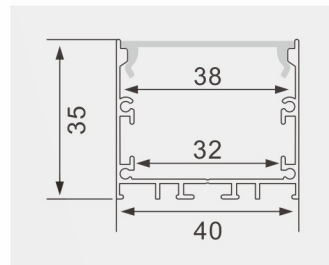

4035A

产品参数

尺寸: Lx55x35mm
材质: 6063-T5 铝合金
表面: 氧化铝本色/喷漆 (黑色/白色)
PC罩: 乳白/黑色/亚克力磨砂可选
适用: 38MM软灯带/硬灯条

Description

size: Lx55x35mm
Material: 6063-T5
Surface: Silver / black / white Anodized
PC cover: Milky white/black/acrylic matte
Apply: LED Strips and PCB 38mm

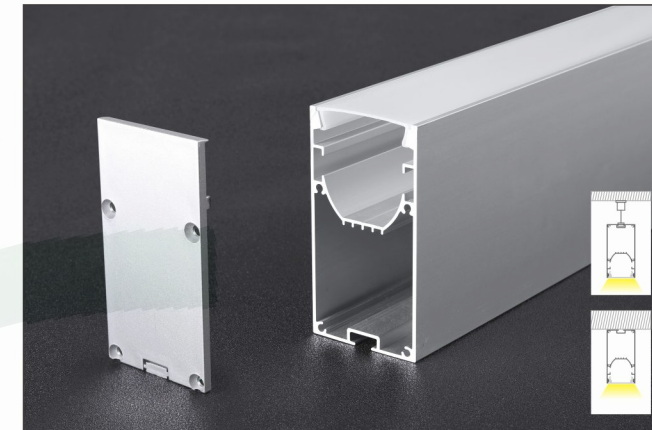
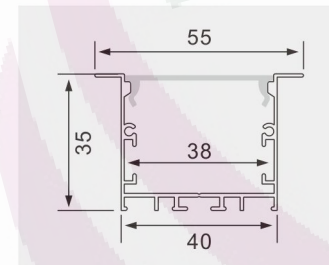

4075M

产品参数

尺寸: Lx40x75mm
材质: 6063-T5 铝合金
表面: 氧化铝本色/喷漆 (黑色/白色)
PC罩: 乳白/黑色/亚克力磨砂可选
适用: 15MM软灯带/硬灯条

Description

size: Lx40x75mm
Material: 6063-T5
Surface: Silver / black / white Anodized
PC cover: Milky white/black/acrylic matte
Apply: LED Strips and PCB 15mm

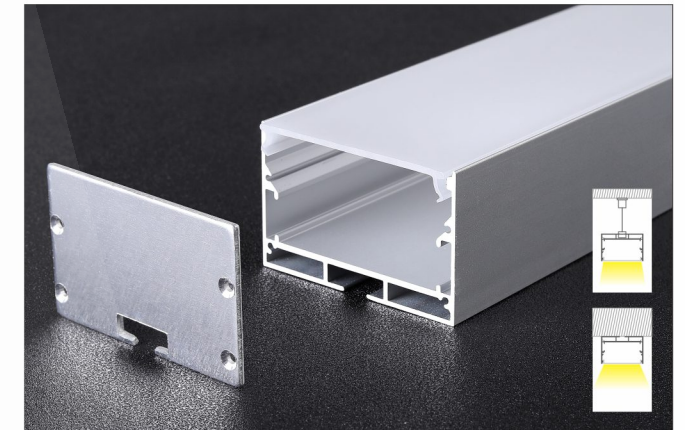
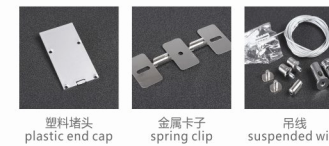
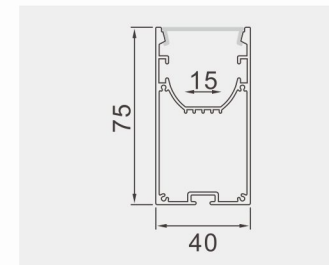

706

产品参数

尺寸: Lx49x32mm
材质: 6063-T5 铝合金
表面: 氧化铝本色/喷漆 (黑色/白色)
PC罩: 乳白/黑色/亚克力磨砂可选
适用: 45MM软灯带/硬灯条

Description

size: Lx49x32mm
Material: 6063-T5
Surface: Silver / black / white Anodized
PC cover: Milky white/black/acrylic matte
Apply: LED Strips and PCB 45mm

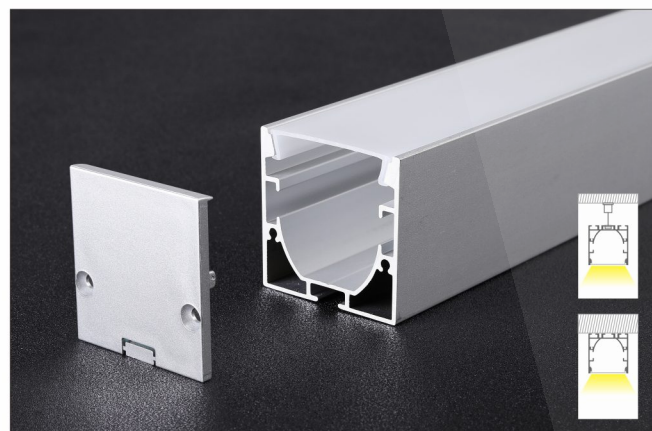
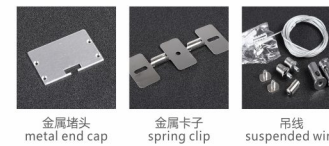
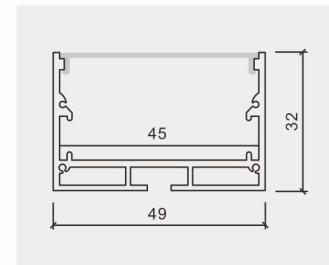

4040M

产品参数

尺寸: Lx40x40mm
材质: 6063-T5 铝合金
表面: 氧化铝本色/喷漆 (黑色/白色)
PC罩: 乳白/黑色/亚克力磨砂可选
适用: 15MM软灯带/硬灯条

Description

size: Lx40x40mm
Material: 6063-T5
Surface: Silver / black / white Anodized
PC cover: Milky white/black/acrylic matte
Apply: LED Strips and PCB 15mm

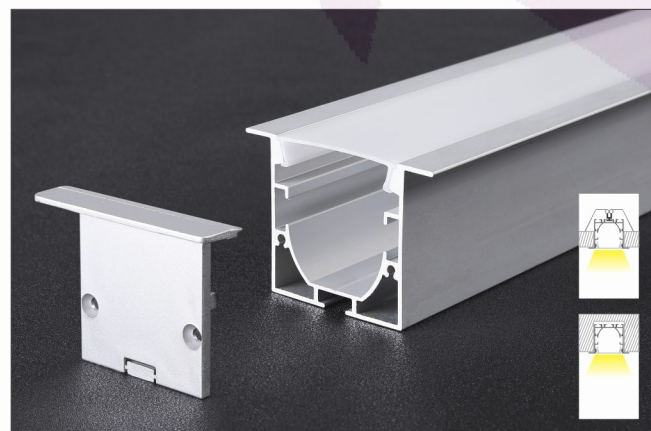
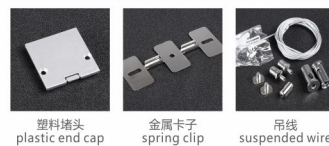
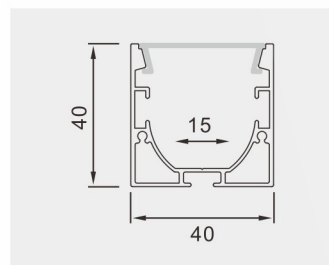

4040A

产品参数

尺寸: Lx56x40mm
材质: 6063-T5 铝合金
表面: 氧化铝本色/喷漆 (黑色/白色)
PC罩: 乳白/黑色/亚克力磨砂可选
适用: 15MM软灯带/硬灯条

Description

size: Lx56x40mm
Material: 6063-T5
Surface: Silver / black / white Anodized
PC cover: Milky white/black/acrylic matte
Apply: LED Strips and PCB 15mm

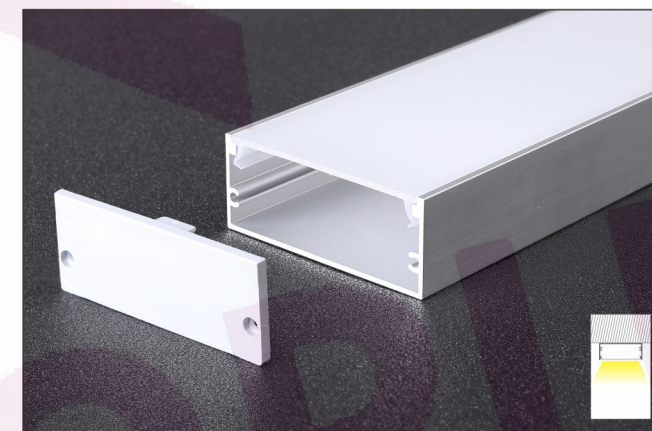
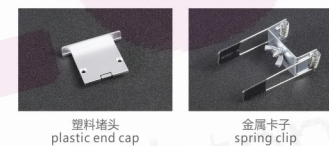
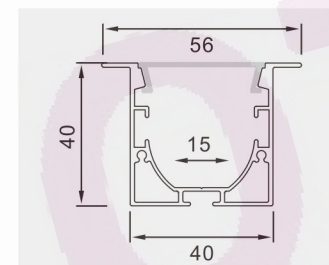

5020M

产品参数

尺寸: Lx50x20mm
材质: 6063-T5 铝合金
表面: 氧化铝本色/喷漆 (黑色/白色)
PC罩: 乳白/黑色/亚克力磨砂可选
适用: 47MM软灯带/硬灯条

Description

size: Lx50x20mm
Material: 6063-T5
Surface: Silver / black / white Anodized
PC cover: Milky white/black/acrylic matte
Apply: LED Strips and PCB 47mm

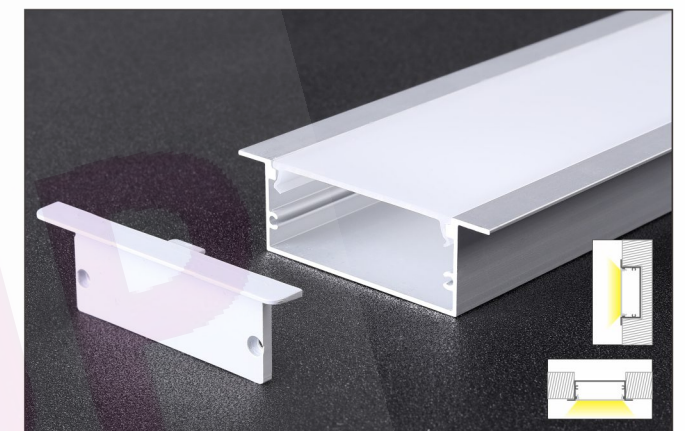
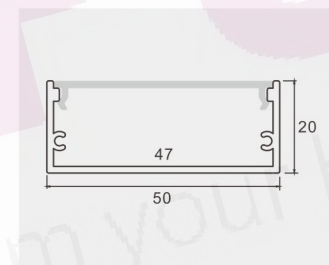

5020A

产品参数

尺寸: Lx65x20mm
材质: 6063-T5 铝合金
表面: 氧化铝本色/喷漆 (黑色/白色)
PC罩: 乳白/黑色/亚克力磨砂可选
适用: 47MM软灯带/硬灯条

Description

size: Lx65x20mm
Material: 6063-T5
Surface: Silver / black / white Anodized
PC cover: Milky white/black/acrylic matte
Apply: LED Strips and PCB 47mm

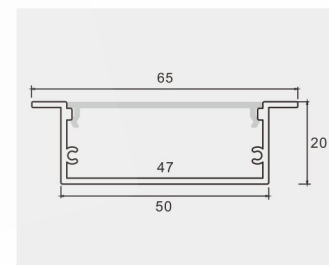

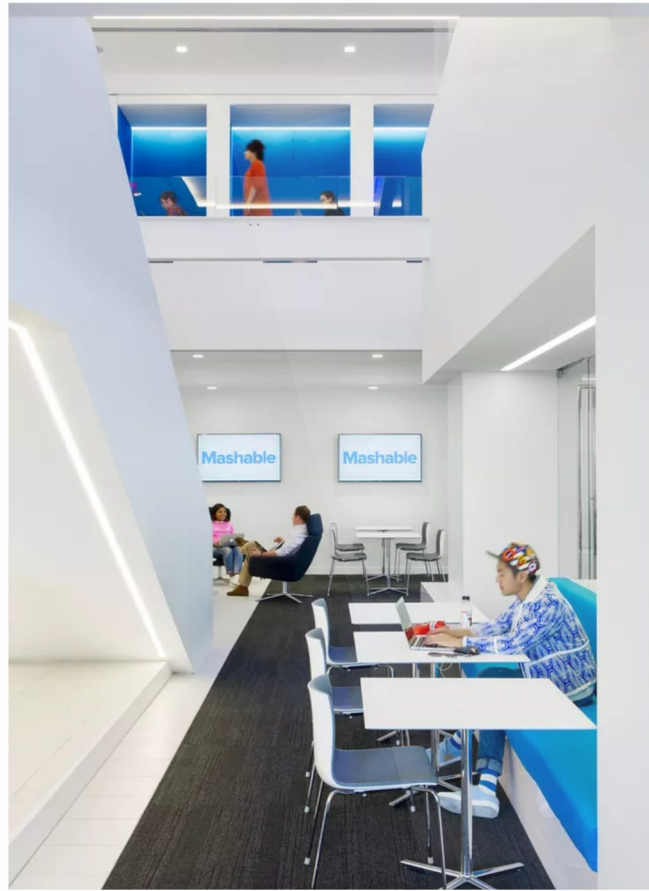

5035M

产品参数
尺寸: Lx50x35mm
材质: 6063-T5 铝合金
表面: 氧化铝本色/喷漆 (黑色/白色)
PC罩: 乳白/黑色/亚克力磨砂可选
适用: 43MM软灯带/硬灯条

Description
size: Lx50x35mm
Material: 6063-T5
Surface: Silver / black / white Anodized
PC cover: Milky white/black/acrylic matte
Apply: LED Strips and PCB 43mm

塑料堵头 plastic end cap 金属卡子 spring clip 吊线 suspended wire

5035A厚款

产品参数
尺寸: Lx65x35mm
材质: 6063-T5 铝合金
表面: 氧化铝本色/喷漆 (黑色/白色)
PC罩: 乳白/黑色/亚克力磨砂可选
适用: 43MM软灯带/硬灯条

Description
size: Lx65x35mm
Material: 6063-T5
Surface: Silver / black / white Anodized
PC cover: Milky white/black/acrylic matte
Apply: LED Strips and PCB 43mm

塑料堵头 plastic end cap 金属卡子 spring clip

5040M

产品参数
尺寸: Lx50x40mm
材质: 6063-T5 铝合金
表面: 氧化铝本色/喷漆 (黑色/白色)
PC罩: 乳白/黑色/亚克力磨砂可选
适用: 25MM软灯带/硬灯条

Description
size: Lx50x40mm
Material: 6063-T5
Surface: Silver / black / white Anodized
PC cover: Milky white/black/acrylic matte
Apply: LED Strips and PCB 25mm

塑料堵头 plastic end cap 金属卡子 spring clip 吊线 suspended wire

5035A

产品参数
尺寸: Lx65x35mm
材质: 6063-T5 铝合金
表面: 氧化铝本色/喷漆 (黑色/白色)
PC罩: 乳白/黑色/亚克力磨砂可选
适用: 43MM软灯带/硬灯条

Description
size: Lx65x35mm
Material: 6063-T5
Surface: Silver / black / white Anodized
PC cover: Milky white/black/acrylic matte
Apply: LED Strips and PCB 43mm

塑料堵头 plastic end cap 金属卡子 spring clip

5035M厚款

产品参数
尺寸: Lx50x35mm
材质: 6063-T5 铝合金
表面: 氧化铝本色/喷漆 (黑色/白色)
PC罩: 乳白/黑色/亚克力磨砂可选
适用: 43MM软灯带/硬灯条

Description
size: Lx50x35mm
Material: 6063-T5
Surface: Silver / black / white Anodized
PC cover: Milky white/black/acrylic matte
Apply: LED Strips and PCB 43mm

塑料堵头 plastic end cap 金属卡子 spring clip 吊线 suspended wire

5040A

产品参数
尺寸: Lx66x40mm
材质: 6063-T5 铝合金
表面: 氧化铝本色/喷漆 (黑色/白色)
PC罩: 乳白/黑色/亚克力磨砂可选
适用: 25MM软灯带/硬灯条

Description
size: Lx66x40mm
Material: 6063-T5
Surface: Silver / black / white Anodized
PC cover: Milky white/black/acrylic matte
Apply: LED Strips and PCB 25mm

塑料堵头 plastic end cap 金属卡子 spring clip

5050M

产品参数
尺寸: Lx50x50mm
材质: 6063-T5 铝合金
表面: 氧化铝本色/喷漆 (黑色/白色)
PC罩: 乳白/黑色/亚克力磨砂可选
适用: 38MM软灯带/硬灯条

Description
size: Lx50x50mm
Material: 6063-T5
Surface: Silver / black / white Anodized
PC cover: Milky white/black/acrylic matte
Apply: LED Strips and PCB 38mm

金属堵头 metal end cap 金属卡子 spring clip 吊线 suspended wire

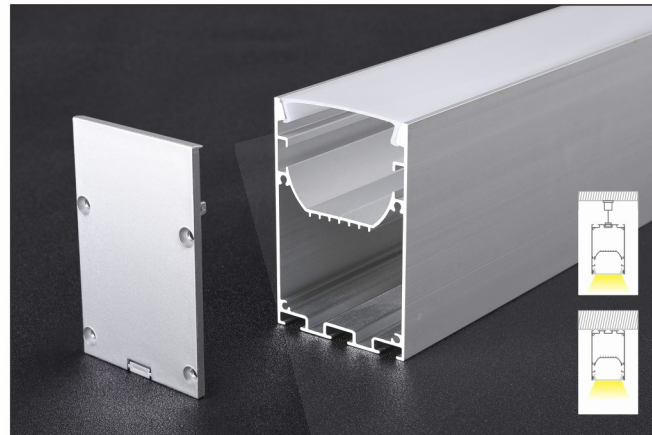

5075M

产品参数

尺寸: Lx50x75mm
材质: 6063-T5 铝合金
表面: 氧化铝本色/喷漆 (黑色/白色)
PC罩: 乳白/黑色/亚克力磨砂可选
适用: 25MM软灯带/硬灯条

Description

size: Lx50x75mm
Material: 6063-T5
Surface: Silver / black / white Anodized
PC cover: Milky white/black/acrylic matte
Apply: LED Strips and PCB 25mm

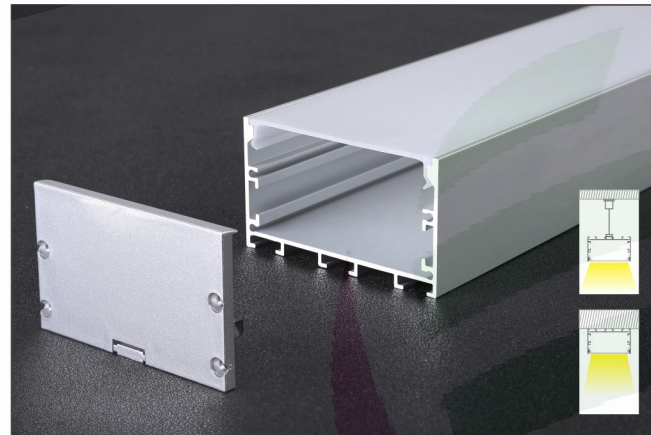
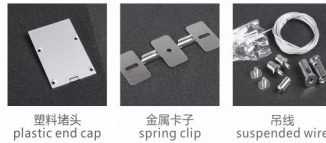
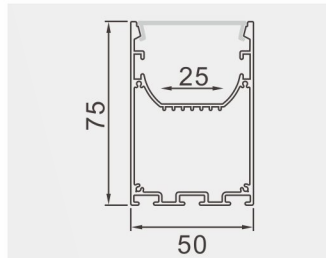

6035M

产品参数

尺寸: Lx60x35mm
材质: 6063-T5 铝合金
表面: 氧化铝本色/喷漆 (黑色/白色)
PC罩: 乳白/黑色/亚克力磨砂可选
适用: 58MM软灯带/硬灯条

Description

size: Lx60x35mm
Material: 6063-T5
Surface: Silver / black / white Anodized
PC cover: Milky white/black/acrylic matte
Apply: LED Strips and PCB 58mm

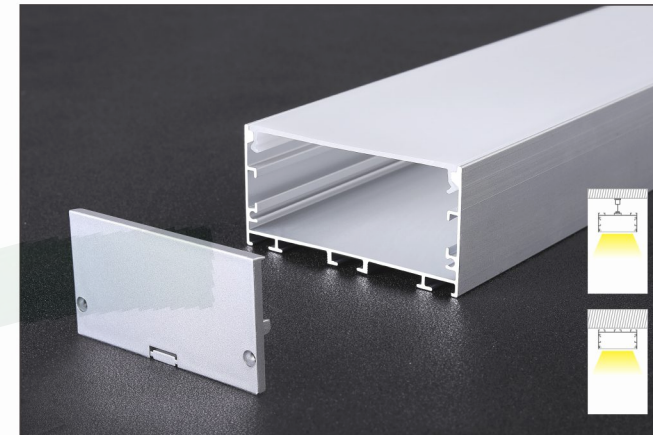
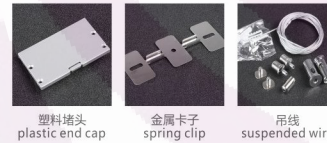
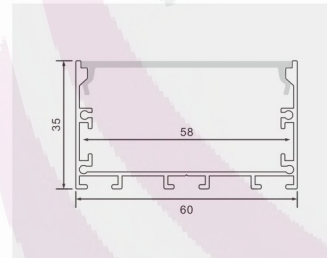

7035M

产品参数

尺寸: Lx70x35mm
材质: 6063-T5 铝合金
表面: 氧化铝本色/喷漆 (黑色/白色)
PC罩: 乳白/黑色/亚克力磨砂可选
适用: 67MM软灯带/硬灯条

Description

size: Lx70x35mm
Material: 6063-T5
Surface: Silver / black / white Anodized
PC cover: Milky white/black/acrylic matte
Apply: LED Strips and PCB 67mm

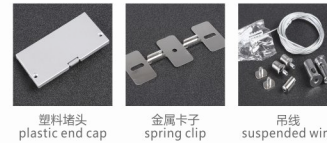
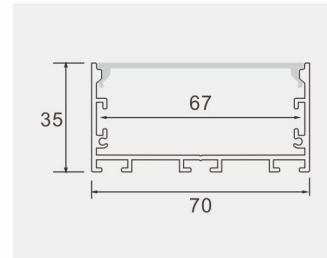

7035A

产品参数

尺寸: Lx86x35mm
材质: 6063-T5 铝合金
表面: 氧化铝本色/喷漆 (黑色/白色)
PC罩: 乳白/黑色/亚克力磨砂可选
适用: 67MM软灯带/硬灯条

Description

size: Lx86x35mm
Material: 6063-T5
Surface: Silver / black / white Anodized
PC cover: Milky white/black/acrylic matte
Apply: LED Strips and PCB 67mm

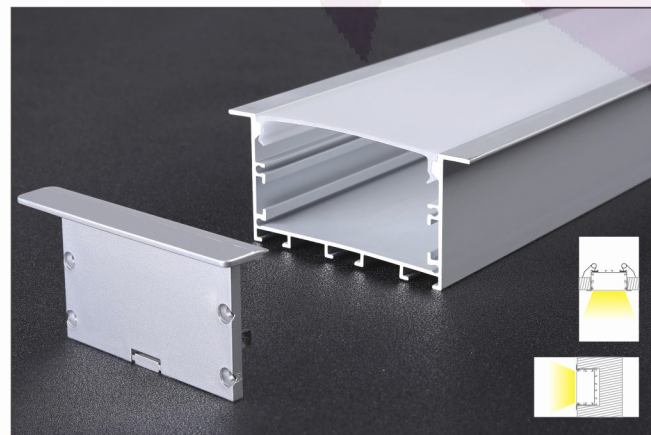
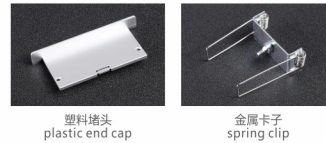
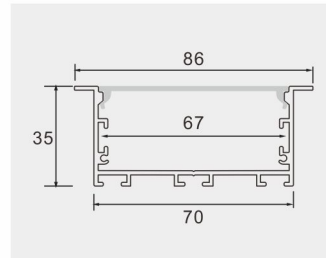

6035A

产品参数

尺寸: Lx76x35mm
材质: 6063-T5 铝合金
表面: 氧化铝本色/喷漆 (黑色/白色)
PC罩: 乳白/黑色/亚克力磨砂可选
适用: 58MM软灯带/硬灯条

Description

size: Lx76x35mm
Material: 6063-T5
Surface: Silver / black / white Anodized
PC cover: Milky white/black/acrylic matte
Apply: LED Strips and PCB 58mm

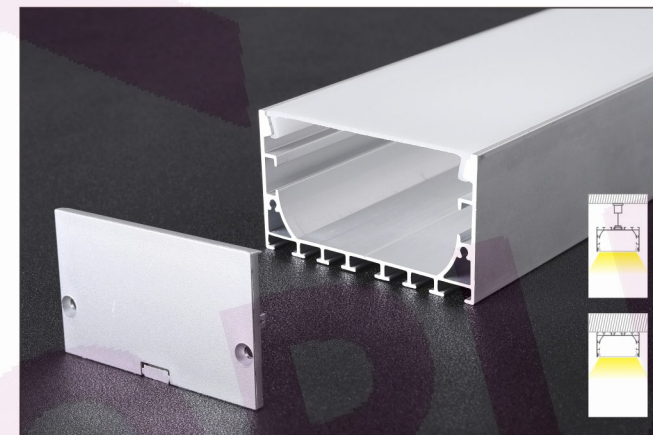
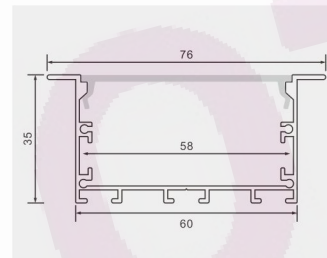

7040M

产品参数

尺寸: Lx70x40mm
材质: 6063-T5 铝合金
表面: 氧化铝本色/喷漆 (黑色/白色)
PC罩: 乳白/黑色/亚克力磨砂可选
适用: 45MM软灯带/硬灯条

Description

size: Lx70x40mm
Material: 6063-T5
Surface: Silver / black / white Anodized
PC cover: Milky white/black/acrylic matte
Apply: LED Strips and PCB 45mm

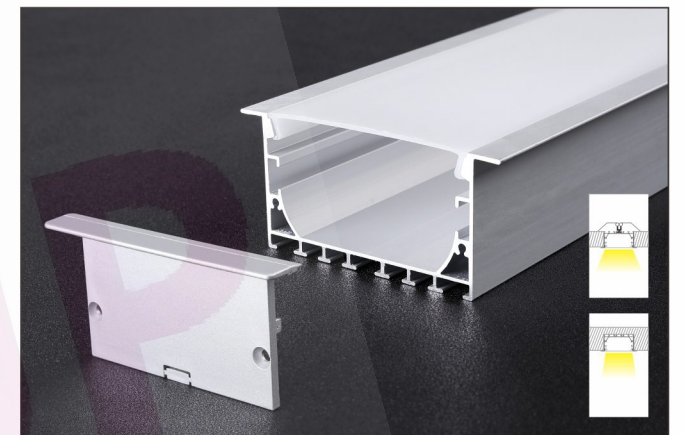
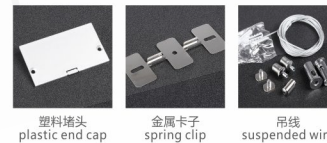
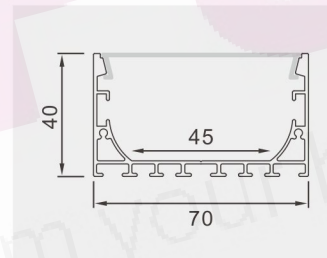

7040A

产品参数

尺寸: Lx86x40mm
材质: 6063-T5 铝合金
表面: 氧化铝本色/喷漆 (黑色/白色)
PC罩: 乳白/黑色/亚克力磨砂可选
适用: 45MM软灯带/硬灯条

Description

size: Lx86x40mm
Material: 6063-T5
Surface: Silver / black / white Anodized
PC cover: Milky white/black/acrylic matte
Apply: LED Strips and PCB 45mm

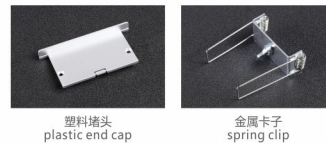
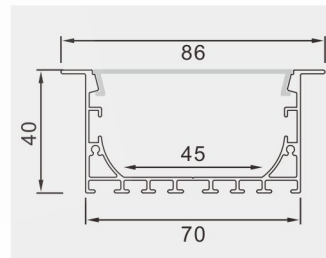

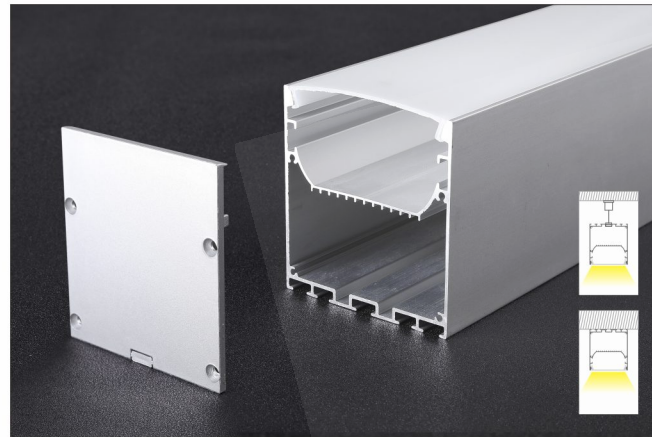

7075M

产品参数

尺寸: Lx70x75mm
材质: 6063-T5 铝合金
表面: 氧化铝本色/喷漆 (黑色/白色)
PC罩: 乳白/黑色/亚克力磨砂可选
适用: 45MM软灯带/硬灯条

Description

size: Lx70x75mm
Material: 6063-T5
Surface: Silver / black / white Anodized
PC cover: Milky white/black/acrylic matte
Apply: LED Strips and PCB 45mm

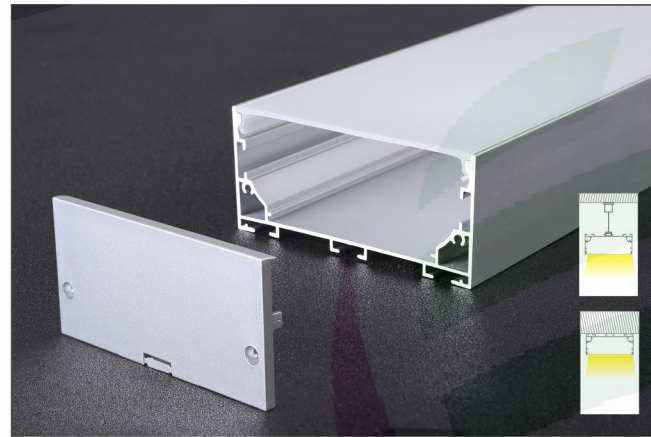
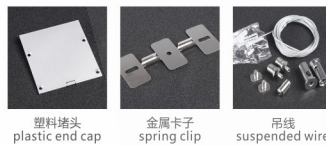
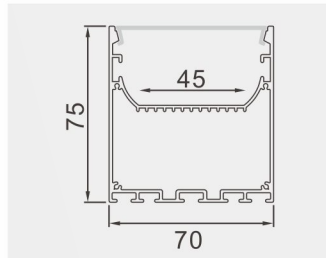

7635M

产品参数

尺寸: Lx76x35mm
材质: 6063-T5 铝合金
表面: 氧化铝本色/喷漆 (黑色/白色)
PC罩: 乳白/黑色/亚克力磨砂可选
适用: 54MM软灯带/硬灯条

Description

size: Lx76x35mm
Material: 6063-T5
Surface: Silver / black / white Anodized
PC cover: Milky white/black/acrylic matte
Apply: LED Strips and PCB 54mm

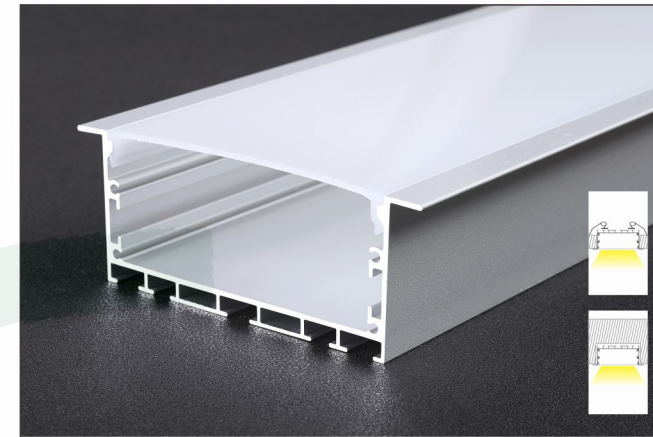
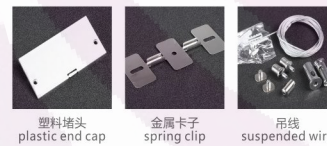
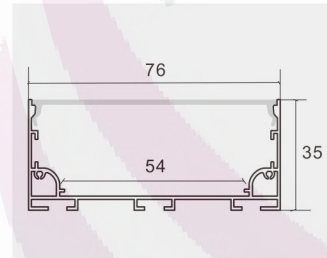

7635A厚款

产品参数

尺寸: Lx92.5x35mm
材质: 6063-T5 铝合金
表面: 氧化铝本色/喷漆 (黑色/白色)
PC罩: 乳白/黑色/亚克力磨砂可选
适用: 67MM软灯带/硬灯条

Description

size: Lx92.5x35mm
Material: 6063-T5
Surface: Silver / black / white Anodized
PC cover: Milky white/black/acrylic matte
Apply: LED Strips and PCB 67mm

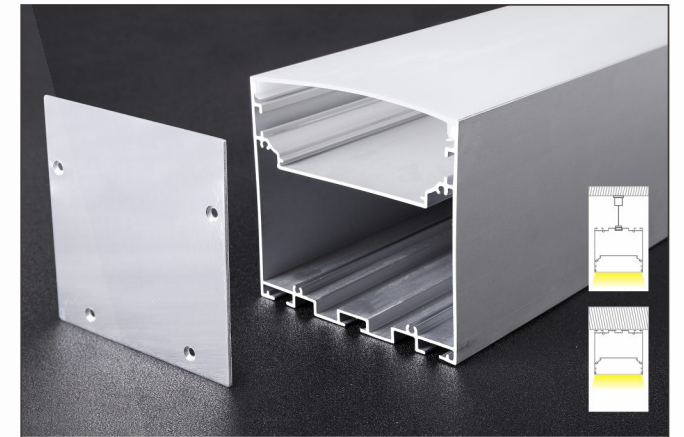
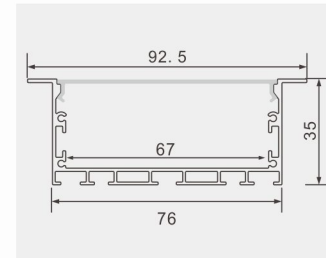

7676M

产品参数

尺寸: Lx76x76mm
材质: 6063-T5 铝合金
表面: 氧化铝本色/喷漆 (黑色/白色)
PC罩: 乳白/黑色/亚克力磨砂可选
适用: 54MM软灯带/硬灯条

Description

size: Lx76x76mm
Material: 6063-T5
Surface: Silver / black / white Anodized
PC cover: Milky white/black/acrylic matte
Apply: LED Strips and PCB 54mm

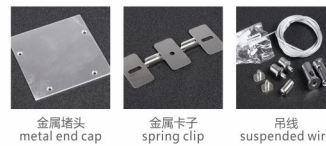
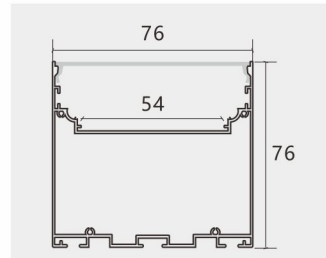

7635A

产品参数

尺寸: Lx90x35mm
材质: 6063-T5 铝合金
表面: 氧化铝本色/喷漆 (黑色/白色)
PC罩: 乳白/黑色/亚克力磨砂可选
适用: 53MM软灯带/硬灯条

Description

size: Lx90x35mm
Material: 6063-T5
Surface: Silver / black / white Anodized
PC cover: Milky white/black/acrylic matte
Apply: LED Strips and PCB 53mm

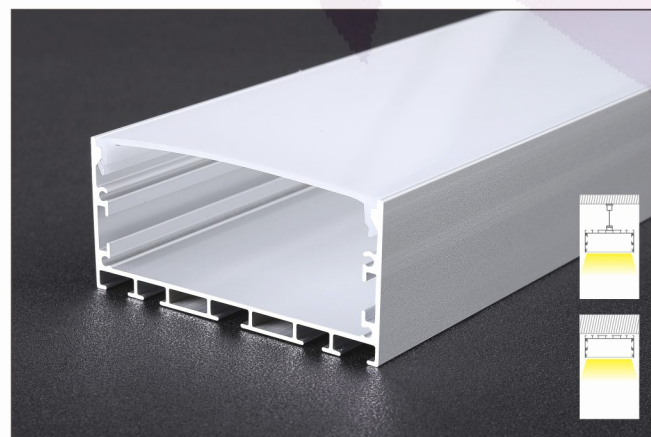
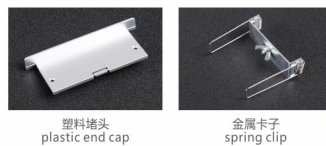
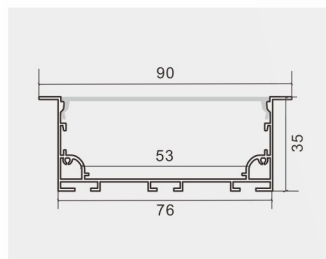

7635M厚款

产品参数

尺寸: Lx76x35mm
材质: 6063-T5 铝合金
表面: 氧化铝本色/喷漆 (黑色/白色)
PC罩: 乳白/黑色/亚克力磨砂可选
适用: 67MM软灯带/硬灯条

Description

size: Lx76x35mm
Material: 6063-T5
Surface: Silver / black / white Anodized
PC cover: Milky white/black/acrylic matte
Apply: LED Strips and PCB 67mm

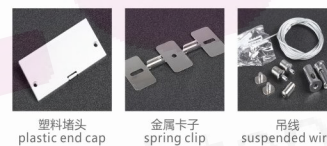
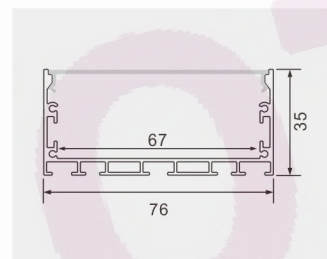

8035M

产品参数

尺寸: Lx80x35mm
材质: 6063-T5 铝合金
表面: 氧化铝本色/喷漆 (黑色/白色)
PC罩: 乳白/黑色/亚克力磨砂可选
适用: 77MM软灯带/硬灯条

Description

size: Lx80x35mm
Material: 6063-T5
Surface: Silver / black / white Anodized
PC cover: Milky white/black/acrylic matte
Apply: LED Strips and PCB 77mm

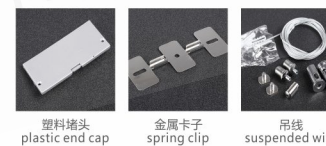
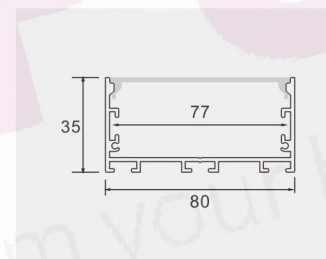

8035A

产品参数

尺寸: Lx96x35mm
材质: 6063-T5 铝合金
表面: 氧化铝本色/喷漆 (黑色/白色)
PC罩: 乳白/黑色/亚克力磨砂可选
适用: 77MM软灯带/硬灯条

Description

size: Lx96x35mm
Material: 6063-T5
Surface: Silver / black / white Anodized
PC cover: Milky white/black/acrylic matte
Apply: LED Strips and PCB 77mm

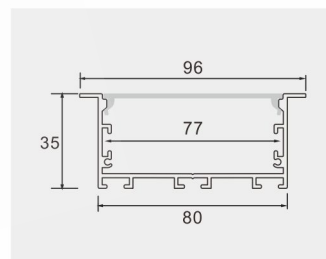

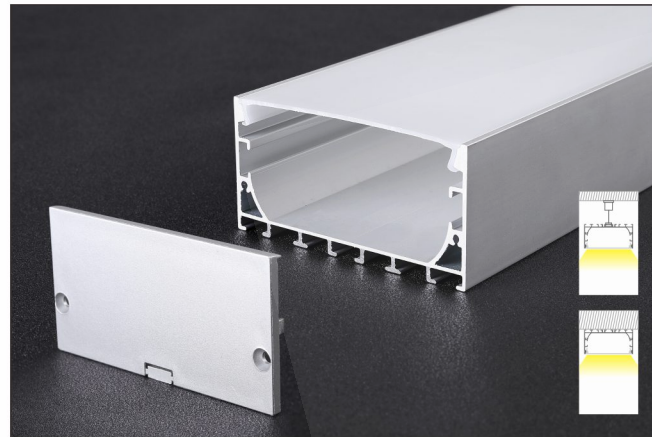

8040M

产品参数

尺寸: Lx80x40mm
材质: 6063-T5 铝合金
表面: 氧化铝本色/喷漆 (黑色/白色)
PC罩: 乳白/黑色/亚克力磨砂可选
适用: 55MM软灯带/硬灯条

Description

size: Lx80x40mm
Material: 6063-T5
Surface: Silver / black / white Anodized
PC cover: Milky white/black/acrylic matte
Apply: LED Strips and PCB 55mm

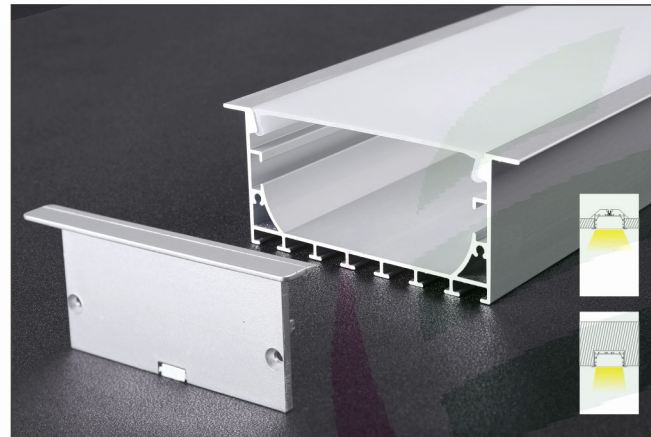
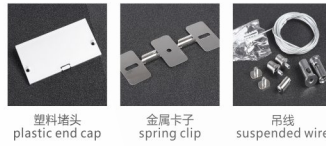
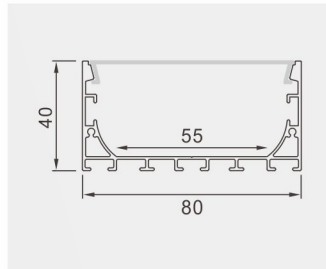

8040A

产品参数

尺寸: Lx96x40mm
材质: 6063-T5 铝合金
表面: 氧化铝本色/喷漆 (黑色/白色)
PC罩: 乳白/黑色/亚克力磨砂可选
适用: 55MM软灯带/硬灯条

Description

size: Lx96x40mm
Material: 6063-T5
Surface: Silver / black / white Anodized
PC cover: Milky white/black/acrylic matte
Apply: LED Strips and PCB 55mm

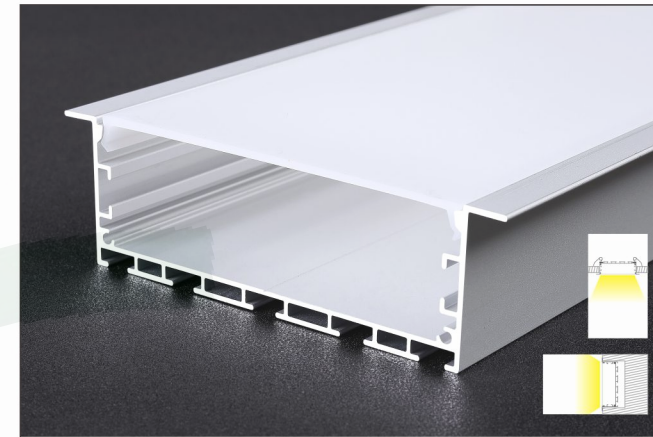
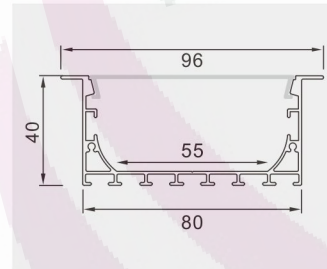

10035A厚款

产品参数

尺寸: Lx116.5x35mm
材质: 6063-T5 铝合金
表面: 氧化铝本色/喷漆 (黑色/白色)
PC罩: 乳白/黑色/亚克力磨砂可选
适用: 88MM软灯带/硬灯条

Description

size: Lx116.5x35mm
Material: 6063-T5
Surface: Silver / black / white Anodized
PC cover: Milky white/black/acrylic matte
Apply: LED Strips and PCB 88mm

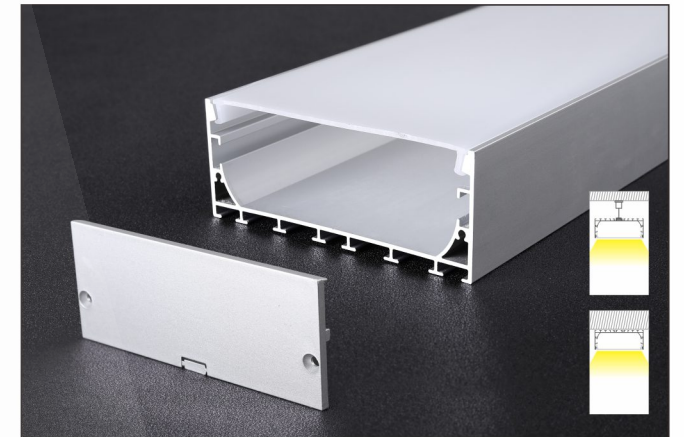
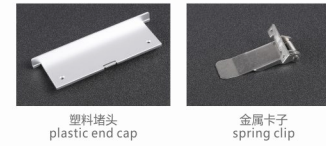
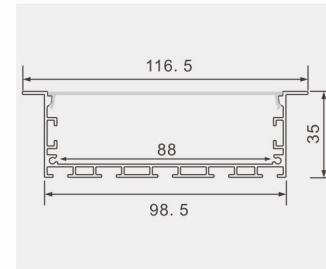

10040M

产品参数

尺寸: Lx100x40mm
材质: 6063-T5 铝合金
表面: 氧化铝本色/喷漆 (黑色/白色)
PC罩: 乳白/黑色/亚克力磨砂可选
适用: 75MM软灯带/硬灯条

Description

size: Lx100x40mm
Material: 6063-T5
Surface: Silver / black / white Anodized
PC cover: Milky white/black/acrylic matte
Apply: LED Strips and PCB 75mm

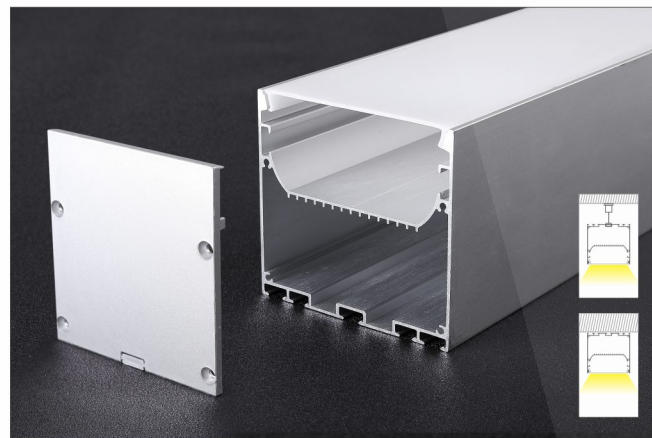
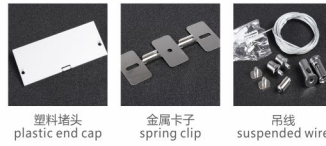
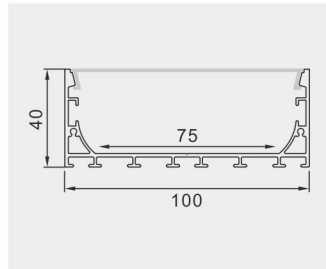

8075M

产品参数

尺寸: Lx80x75mm
材质: 6063-T5 铝合金
表面: 氧化铝本色/喷漆 (黑色/白色)
PC罩: 乳白/黑色/亚克力磨砂可选
适用: 55MM软灯带/硬灯条

Description

size: Lx80x75mm
Material: 6063-T5
Surface: Silver / black / white Anodized
PC cover: Milky white/black/acrylic matte
Apply: LED Strips and PCB 55mm

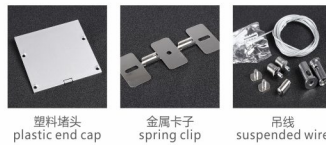
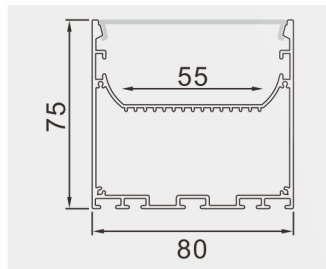

10035M厚款

产品参数

尺寸: Lx98.5x35mm
材质: 6063-T5 铝合金
表面: 氧化铝本色/喷漆 (黑色/白色)
PC罩: 乳白/黑色/亚克力磨砂可选
适用: 88MM软灯带/硬灯条

Description

size: Lx98.5x35mm
Material: 6063-T5
Surface: Silver / black / white Anodized
PC cover: Milky white/black/acrylic matte
Apply: LED Strips and PCB 88mm

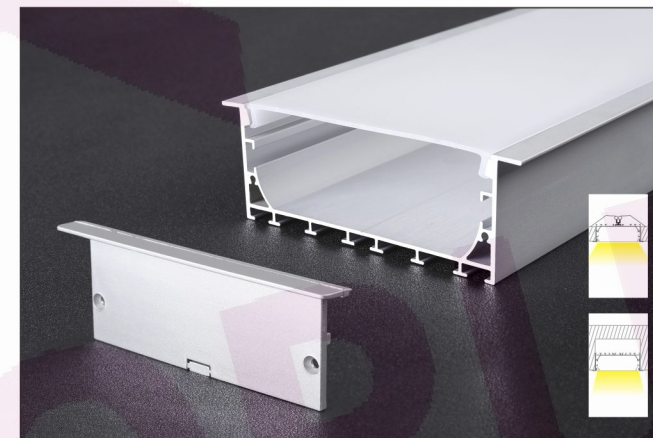
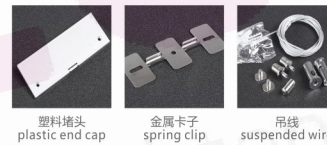
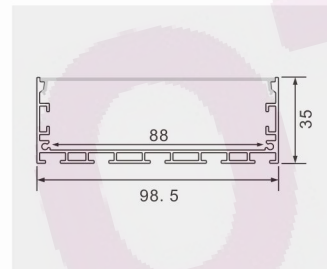

10040A

产品参数

尺寸: Lx116x40mm
材质: 6063-T5 铝合金
表面: 氧化铝本色/喷漆 (黑色/白色)
PC罩: 乳白/黑色/亚克力磨砂可选
适用: 75MM软灯带/硬灯条

Description

size: Lx116x40mm
Material: 6063-T5
Surface: Silver / black / white Anodized
PC cover: Milky white/black/acrylic matte
Apply: LED Strips and PCB 75mm

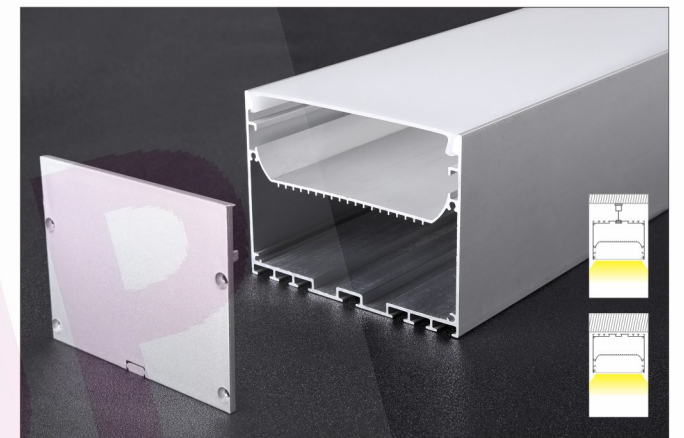
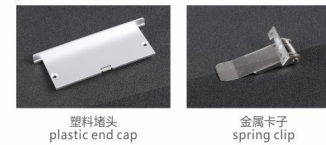
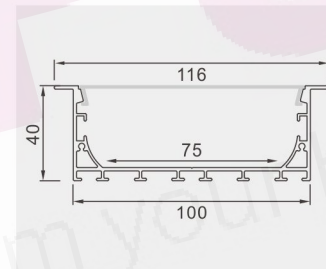

10075M

产品参数

尺寸: Lx100x75mm
材质: 6063-T5 铝合金
表面: 氧化铝本色/喷漆 (黑色/白色)
PC罩: 乳白/黑色/亚克力磨砂可选
适用: 75MM软灯带/硬灯条

Description

size: Lx100x75mm
Material: 6063-T5
Surface: Silver / black / white Anodized
PC cover: Milky white/black/acrylic matte
Apply: LED Strips and PCB 75mm

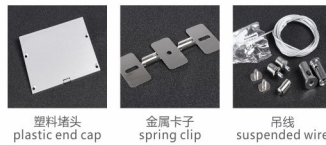
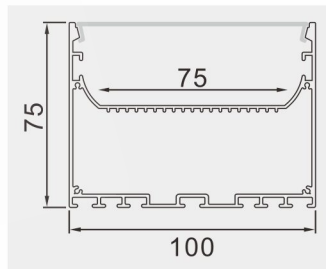

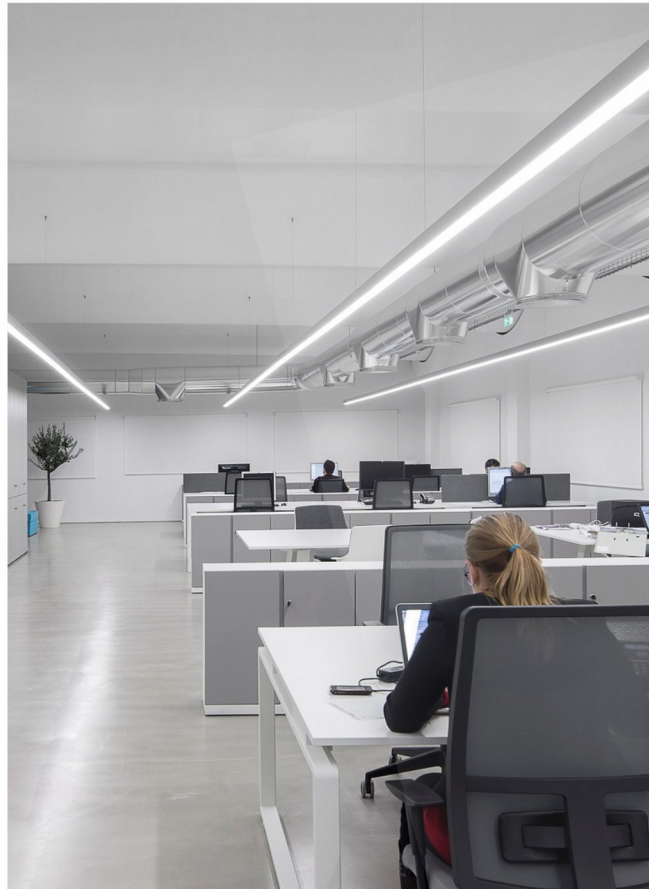

10235M

产品参数
尺寸: Lx102x35mm
材质: 6063-T5 铝合金
表面: 氧化铝本色/喷漆 (黑色/白色)
PC罩: 乳白/黑色/亚克力磨砂可选
适用: 80MM软灯带/硬灯条

Description
size: Lx102x35mm
Material: 6063-T5
Surface: Silver / black / white Anodized
PC cover: Milky white/black/acrylic matte
Apply: LED Strips and PCB 80mm

塑料堵头 plastic end cap 金属卡子 spring clip 吊线 suspended wire

12035A

产品参数
尺寸: Lx135x35mm
材质: 6063-T5 铝合金
表面: 氧化铝本色/喷漆 (黑色/白色)
PC罩: 乳白/黑色/亚克力磨砂可选
适用: 116MM软灯带/硬灯条

Description
size: Lx135x35mm
Material: 6063-T5
Surface: Silver / black / white Anodized
PC cover: Milky white/black/acrylic matte
Apply: LED Strips and PCB 116mm

塑料堵头 plastic end cap 金属卡子 spring clip

12040M

产品参数
尺寸: Lx120x40mm
材质: 6063-T5 铝合金
表面: 氧化铝本色/喷漆 (黑色/白色)
PC罩: 乳白/黑色/亚克力磨砂可选
适用: 95MM软灯带/硬灯条

Description
size: Lx120x40mm
Material: 6063-T5
Surface: Silver / black / white Anodized
PC cover: Milky white/black/acrylic matte
Apply: LED Strips and PCB 95mm

塑料堵头 plastic end cap 金属卡子 spring clip 吊线 suspended wire

10235A

产品参数
尺寸: Lx118x35mm
材质: 6063-T5 铝合金
表面: 氧化铝本色/喷漆 (黑色/白色)
PC罩: 乳白/黑色/亚克力磨砂可选
适用: 80MM软灯带/硬灯条

Description
size: Lx118x35mm
Material: 6063-T5
Surface: Silver / black / white Anodized
PC cover: Milky white/black/acrylic matte
Apply: LED Strips and PCB 80mm

塑料堵头 plastic end cap 金属卡子 spring clip

12035M

产品参数
尺寸: Lx120x35mm
材质: 6063-T5 铝合金
表面: 氧化铝本色/喷漆 (黑色/白色)
PC罩: 乳白/黑色/亚克力磨砂可选
适用: 116MM软灯带/硬灯条

Description
size: Lx120x35mm
Material: 6063-T5
Surface: Silver / black / white Anodized
PC cover: Milky white/black/acrylic matte
Apply: LED Strips and PCB 116mm

塑料堵头 plastic end cap 金属卡子 spring clip 吊线 suspended wire

12040A

产品参数
尺寸: Lx136x40mm
材质: 6063-T5 铝合金
表面: 氧化铝本色/喷漆 (黑色/白色)
PC罩: 乳白/黑色/亚克力磨砂可选
适用: 95MM软灯带/硬灯条

Description
size: Lx136x40mm
Material: 6063-T5
Surface: Silver / black / white Anodized
PC cover: Milky white/black/acrylic matte
Apply: LED Strips and PCB 95mm

塑料堵头 plastic end cap 金属卡子 spring clip

12085M

产品参数
尺寸: Lx120x85mm
材质: 6063-T5 铝合金
表面: 氧化铝本色/喷漆 (黑色/白色)
PC罩: 乳白/黑色/亚克力磨砂可选
适用: 95MM软灯带/硬灯条

Description
size: Lx120x85mm
Material: 6063-T5
Surface: Silver / black / white Anodized
PC cover: Milky white/black/acrylic matte
Apply: LED Strips and PCB 95mm

塑料堵头 plastic end cap 金属卡子 spring clip 吊线 suspended wire



15035M

产品参数

尺寸: Lx150x35mm
材质: 6063-T5 铝合金
表面: 氧化铝本色/喷漆 (黑色/白色)
PC罩: 乳白/黑色/亚克力磨砂可选
适用: 146MM软灯带/硬灯条

Description

size: Lx150x35mm
Material: 6063-T5
Surface: Silver / black / white Anodized
PC cover: Milky white/black/acrylic matte
Apply: LED Strips and PCB 146mm

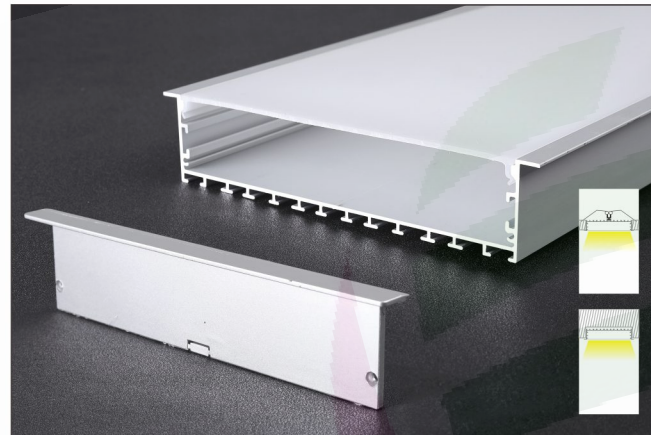
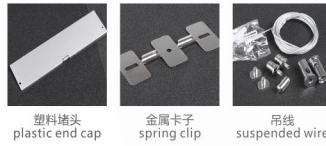
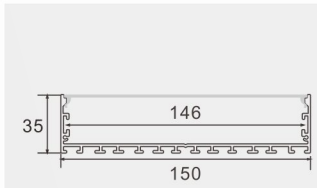

15035A

产品参数

尺寸: Lx165x35mm
材质: 6063-T5 铝合金
表面: 氧化铝本色/喷漆 (黑色/白色)
PC罩: 乳白/黑色/亚克力磨砂可选
适用: 146MM软灯带/硬灯条

Description

size: Lx165x35mm
Material: 6063-T5
Surface: Silver / black / white Anodized
PC cover: Milky white/black/acrylic matte
Apply: LED Strips and PCB 146mm

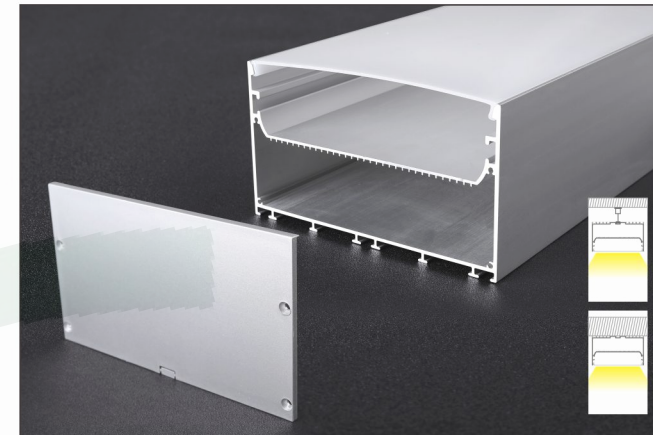
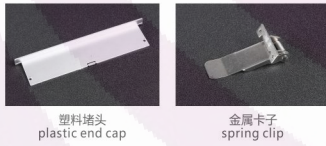
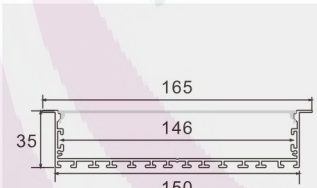

15085M

产品参数

尺寸: Lx150x85mm
材质: 6063-T5 铝合金
表面: 氧化铝本色/喷漆 (黑色/白色)
PC罩: 乳白/黑色/亚克力磨砂可选
适用: 125MM软灯带/硬灯条

Description

size: Lx150x85mm
Material: 6063-T5
Surface: Silver / black / white Anodized
PC cover: Milky white/black/acrylic matte
Apply: LED Strips and PCB 125mm

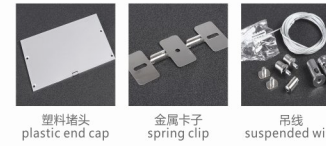
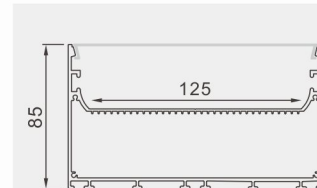

20050M

产品参数

尺寸: Lx200x50mm
材质: 6063-T5 铝合金
表面: 氧化铝本色/喷漆 (黑色/白色)
PC罩: 乳白/黑色/亚克力磨砂可选
适用: 173MM软灯带/硬灯条

Description

size: Lx200x50mm
Material: 6063-T5
Surface: Silver / black / white Anodized
PC cover: Milky white/black/acrylic matte
Apply: LED Strips and PCB 173mm

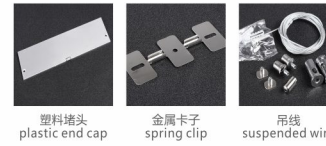
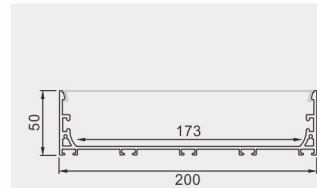

15050M

产品参数

尺寸: Lx150x50mm
材质: 6063-T5 铝合金
表面: 氧化铝本色/喷漆 (黑色/白色)
PC罩: 乳白/黑色/亚克力磨砂可选
适用: 125MM软灯带/硬灯条

Description

size: Lx150x50mm
Material: 6063-T5
Surface: Silver / black / white Anodized
PC cover: Milky white/black/acrylic matte
Apply: LED Strips and PCB 125mm

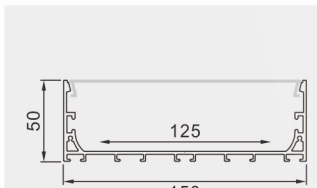

15050A

产品参数

尺寸: Lx166x50mm
材质: 6063-T5 铝合金
表面: 氧化铝本色/喷漆 (黑色/白色)
PC罩: 乳白/黑色/亚克力磨砂可选
适用: 125MM软灯带/硬灯条

Description

size: Lx166x50mm
Material: 6063-T5
Surface: Silver / black / white Anodized
PC cover: Milky white/black/acrylic matte
Apply: LED Strips and PCB 125mm

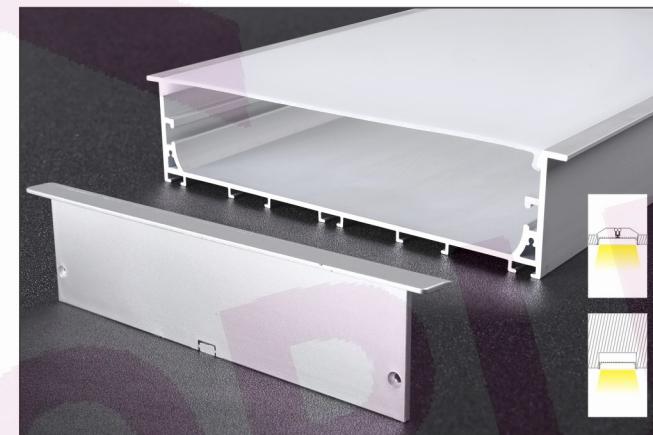
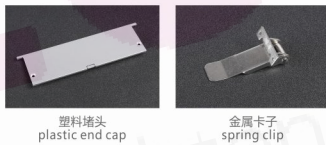
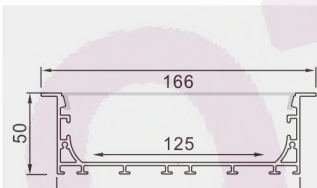

20050A

产品参数

尺寸: Lx216x50mm
材质: 6063-T5 铝合金
表面: 氧化铝本色/喷漆 (黑色/白色)
PC罩: 乳白/黑色/亚克力磨砂可选
适用: 173MM软灯带/硬灯条

Description

size: Lx216x50mm
Material: 6063-T5
Surface: Silver / black / white Anodized
PC cover: Milky white/black/acrylic matte
Apply: LED Strips and PCB 173mm

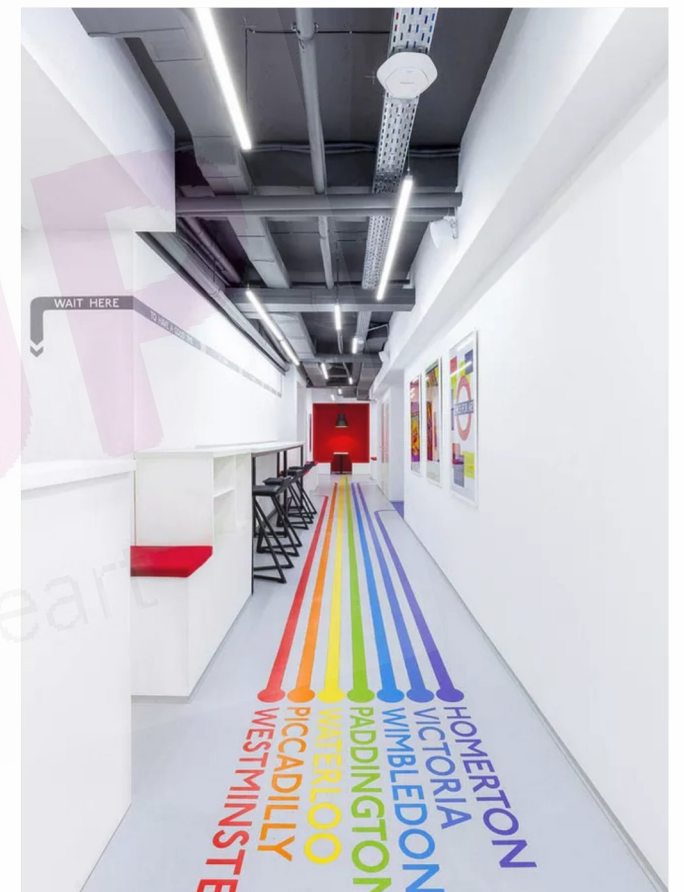
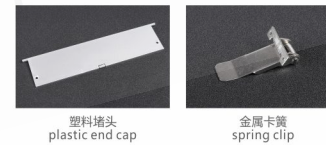
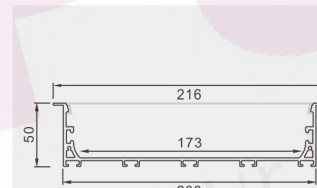

夹层灯 铝型材套件

»» P39-P40



2023
NEW STYLE

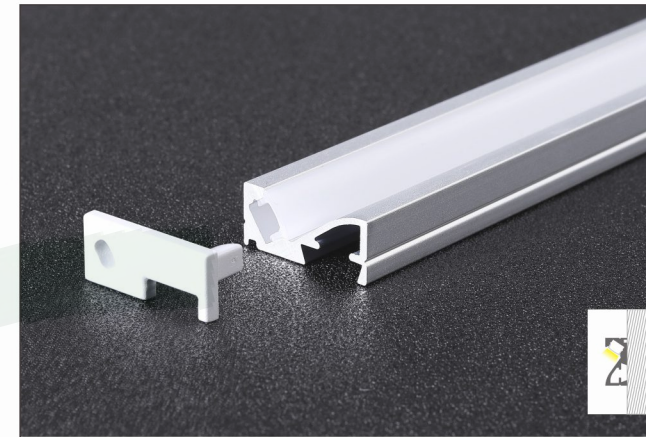

层板-明

产品参数

尺寸: Lx20.8x8.8mm
材质: 6063-T5 铝合金
表面: 氧化铝本色/喷漆 (黑色/白色)
PC罩: 乳白/黑色/亚克力磨砂可选
适用: 5MM软灯带/硬灯条

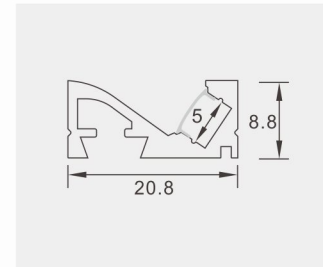

Description

size: Lx20.8x8.8mm
Material: 6063-T5
Surface: Silver / black / white Anodized
PC cover: Milky white/black/acrylic matte
Apply: LED Strips and PCB 5mm



塑料堵头
plastic end cap

金属卡子
spring clip



层板-暗

产品参数

尺寸: Lx23.8x8.8mm
材质: 6063-T5 铝合金
表面: 氧化铝本色/喷漆 (黑色/白色)
PC罩: 乳白/黑色/亚克力磨砂可选
适用: 5MM软灯带/硬灯条

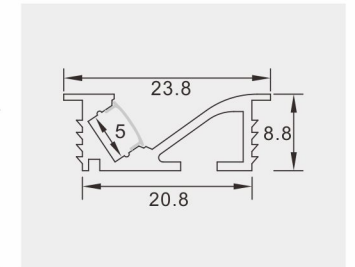

Description

size: Lx23.8x8.8mm
Material: 6063-T5
Surface: Silver / black / white Anodized
PC cover: Milky white/black/acrylic matte
Apply: LED Strips and PCB 5mm

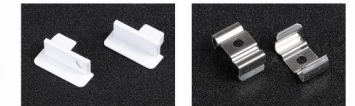

塑料堵头
plastic end cap

金属卡子
spring clip

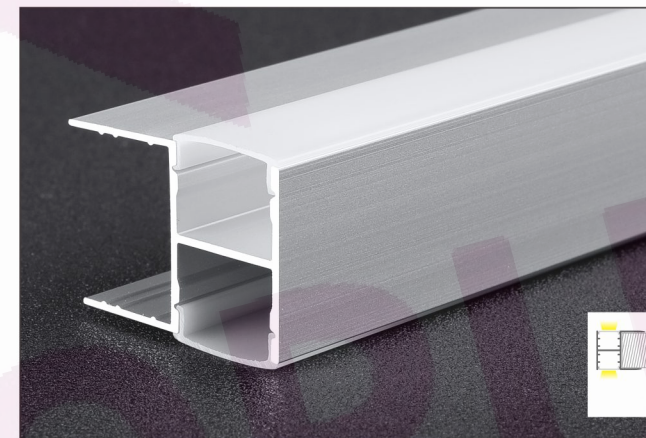

2028

产品参数

尺寸: Lx20x28mm
材质: 6063-T5 铝合金
表面: 氧化铝本色/喷漆 (黑色/白色)
PC罩: 乳白/黑色/亚克力磨砂可选
适用: 12MM软灯带/硬灯条

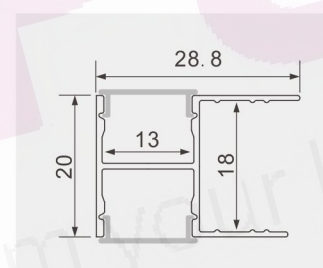

Description

size: Lx20x28mm
Material: 6063-T5
Surface: Silver / black / white Anodized
PC cover: Milky white/black/acrylic matte
Apply: LED Strips and PCB 12mm



多面发光线条灯

铝型材套件

»» P41-P42

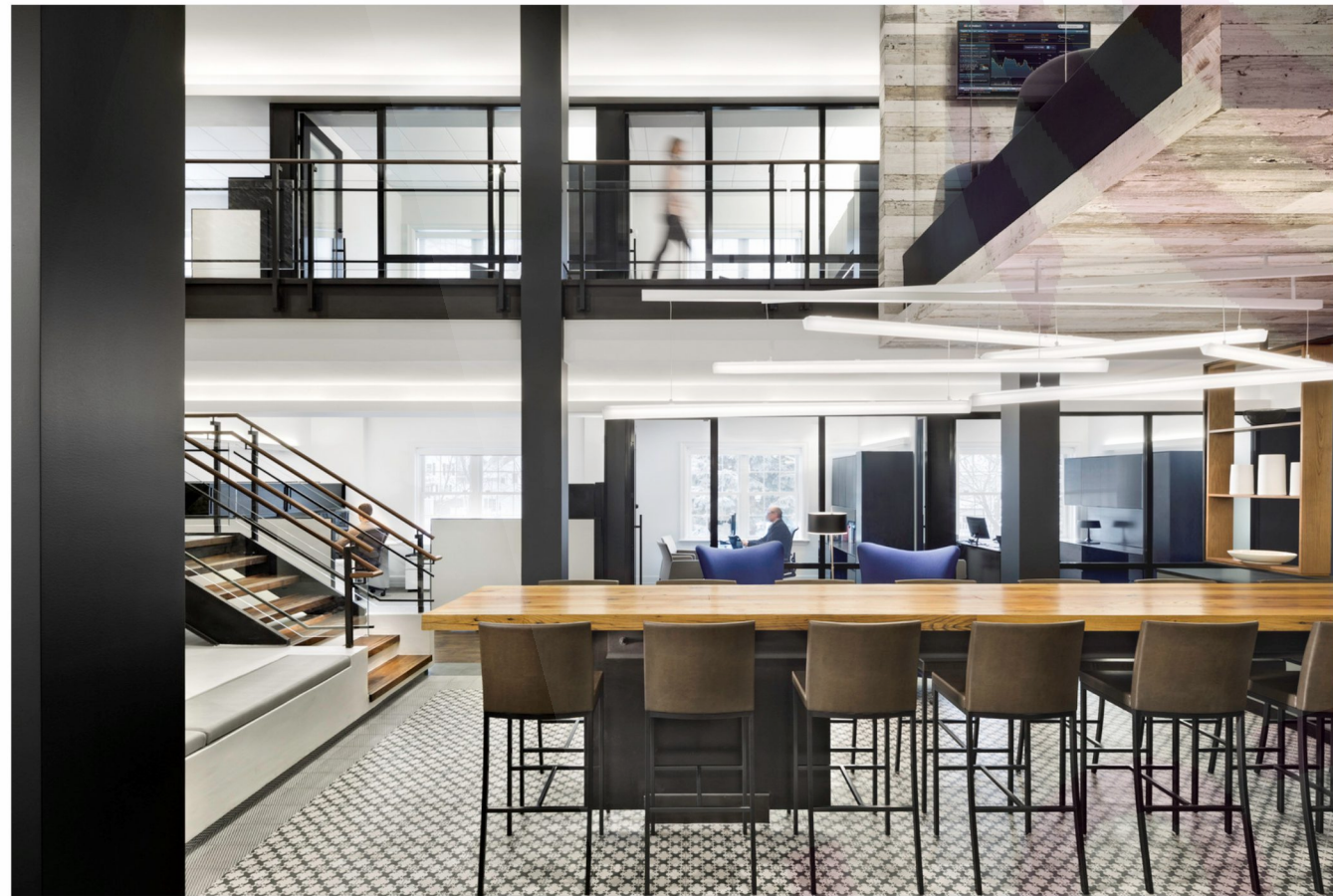

2023
NEW STYLE



Ø30

产品参数

尺寸: LxØ30mm
材质: 6063-T5 铝合金
表面: 氧化铝本色/喷漆 (黑色/白色)
PC罩: 乳白/黑色/亚克力磨砂可选
适用: 20MM软灯带/硬灯条

Description

size: LxØ30mm
Material: 6063-T5
Surface: Silver / black / white Anodized
PC cover: Milky white/black/acrylic matte
Apply: LED Strips and PCB 20mm

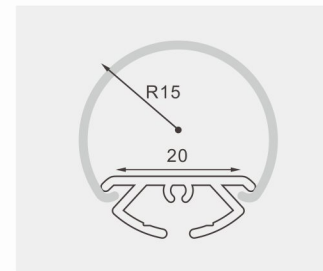

塑料堵头
plastic end cap

金属卡子
spring clip



Ø60

产品参数

尺寸: LxØ60mm
材质: 6063-T5 铝合金
表面: 氧化铝本色/喷漆 (黑色/白色)
PC罩: 乳白/黑色/亚克力磨砂可选
适用: 30MM软灯带/硬灯条

Description

size: LxØ60mm
Material: 6063-T5
Surface: Silver / black / white Anodized
PC cover: Milky white/black/acrylic matte
Apply: LED Strips and PCB 30mm

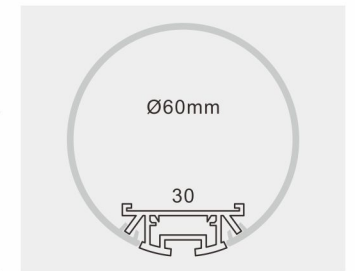

塑料堵头
plastic end cap

金属卡子
spring clip

吊线
suspended wire

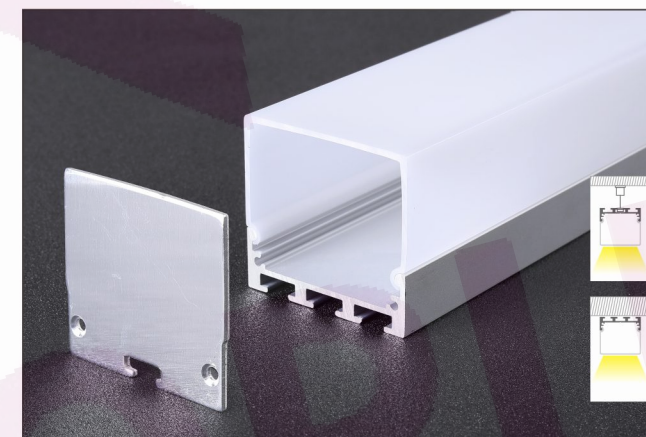

4542方

产品参数

尺寸: Lx45x42mm
材质: 6063-T5 铝合金
表面: 氧化铝本色/喷漆 (黑色/白色)
PC罩: 乳白/黑色/亚克力磨砂可选
适用: 35MM软灯带/硬灯条

Description

size: Lx45x42mm
Material: 6063-T5
Surface: Silver / black / white Anodized
PC cover: Milky white/black/acrylic matte
Apply: LED Strips and PCB 35mm

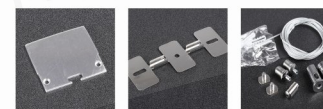
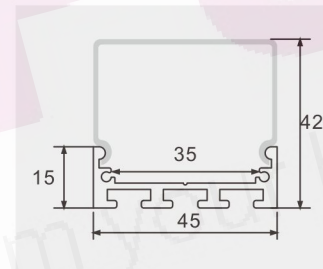

金属堵头
metal end cap

金属卡子
spring clip

吊线
suspended wire

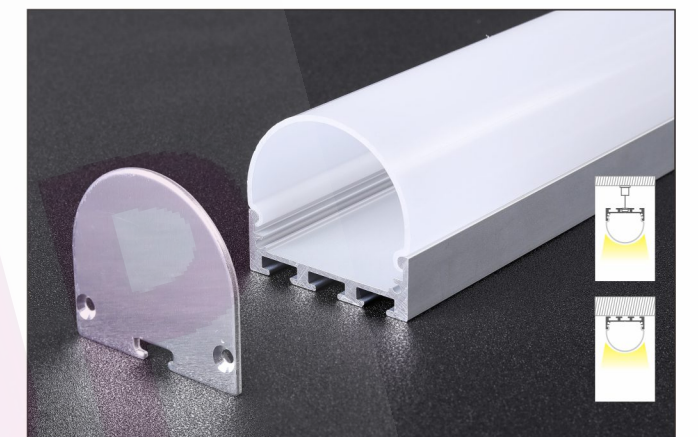

4542圆

产品参数

尺寸: Lx45x42mm
材质: 6063-T5 铝合金
表面: 氧化铝本色/喷漆 (黑色/白色)
PC罩: 乳白/黑色/亚克力磨砂可选
适用: 35MM软灯带/硬灯条

Description

size: Lx45x42mm
Material: 6063-T5
Surface: Silver / black / white Anodized
PC cover: Milky white/black/acrylic matte
Apply: LED Strips and PCB 35mm

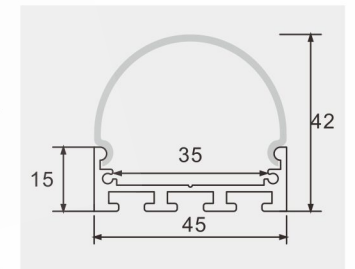

金属堵头
metal end cap

金属卡子
spring clip

吊线
suspended wire

阴阳角线条灯

铝型材套件

>>> P43-P49



2023
NEW STYLE



1010单花边

产品参数

尺寸: Lx30x10mm
材质: 6063-T5 铝合金
表面: 氧化铝本色/喷漆 (黑色/白色)
PC罩: 乳白/黑色/亚克力磨砂可选
适用: 8MM软灯带/硬灯条

Description

size: Lx30x8mm
Material: 6063-T5
Surface: Silver / black / white Anodized
PC cover: Milky white/black/acrylic matte
Apply: LED Strips and PCB 8mm

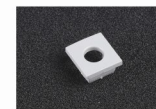
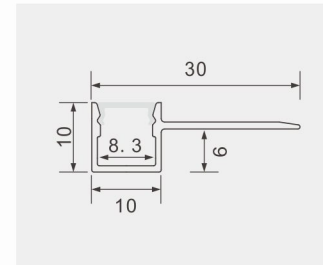

塑料堵头
plastic end cap

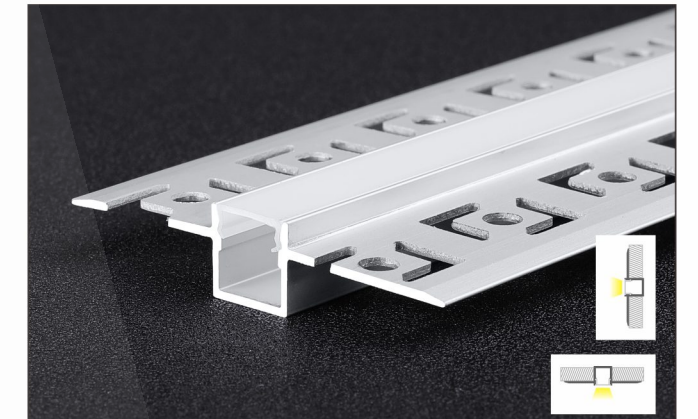

1010上花边

产品参数

尺寸: Lx50x10mm
材质: 6063-T5 铝合金
表面: 氧化铝本色/喷漆 (黑色/白色)
PC罩: 乳白/黑色/亚克力磨砂可选
适用: 8MM软灯带/硬灯条

Description

size: Lx50x10mm
Material: 6063-T5
Surface: Silver / black / white Anodized
PC cover: Milky white/black/acrylic matte
Apply: LED Strips and PCB 8mm

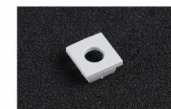
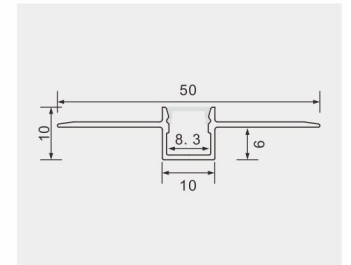

塑料堵头
plastic end cap

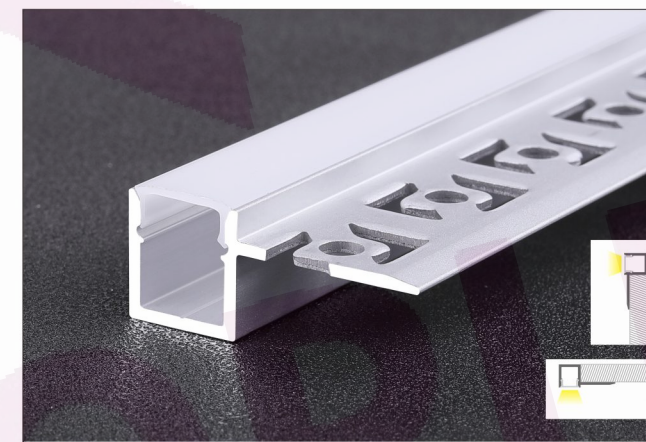

704

产品参数

尺寸: Lx32.5x13.3mm
材质: 6063-T5 铝合金
表面: 氧化铝本色/喷漆 (黑色/白色)
PC罩: 乳白/黑色/亚克力磨砂可选
适用: 9MM软灯带/硬灯条

Description

size: Lx32.5x13.3mm
Material: 6063-T5
Surface: Silver / black / white Anodized
PC cover: Milky white/black/acrylic matte
Apply: LED Strips and PCB 9mm

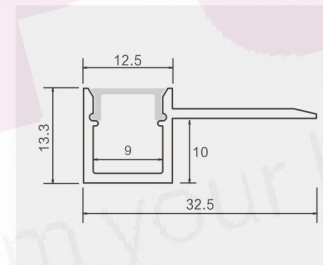

塑料堵头
plastic end cap

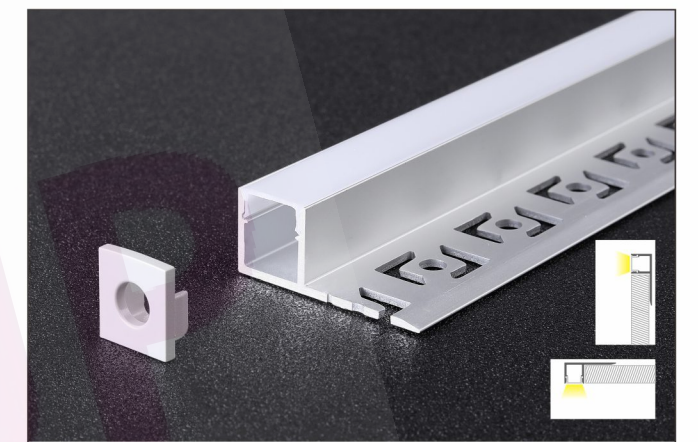

702

产品参数

尺寸: Lx32.5x13.3mm
材质: 6063-T5 铝合金
表面: 氧化铝本色/喷漆 (黑色/白色)
PC罩: 乳白/黑色/亚克力磨砂可选
适用: 9MM软灯带/硬灯条

Description

size: Lx32.5x13.3mm
Material: 6063-T5
Surface: Silver / black / white Anodized
PC cover: Milky white/black/acrylic matte
Apply: LED Strips and PCB 9mm

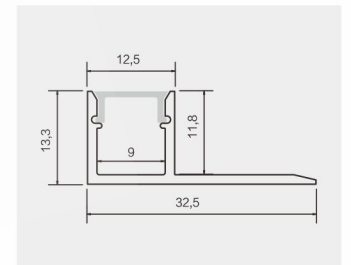

塑料堵头
plastic end cap

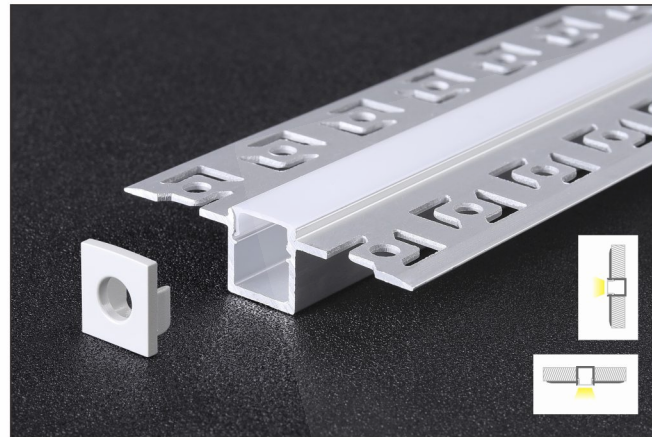

639新款

产品参数

尺寸: Lx52.5x13.3mm
材质: 6063-T5 铝合金
表面: 氧化铝本色/喷漆 (黑色/白色)
PC罩: 乳白/黑色/亚克力磨砂可选
适用: 9MM软灯带/硬灯条

Description

size: Lx52.5x13.3mm
Material: 6063-T5
Surface: Silver / black / white Anodized
PC cover: Milky white/black/acrylic matte
Apply: LED Strips and PCB 9mm

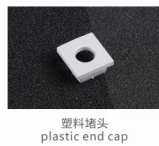
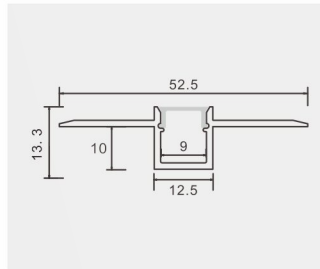

塑料堵头
plastic end cap

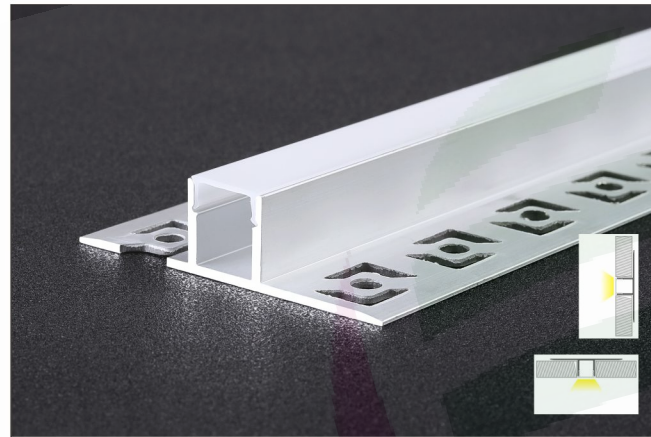

703

产品参数

尺寸: Lx52.5x13.7mm
材质: 6063-T5 铝合金
表面: 氧化铝本色/喷漆 (黑色/白色)
PC罩: 乳白/黑色/亚克力磨砂可选
适用: 9.9MM软灯带/硬灯条

Description

size: Lx52.5x13.7mm
Material: 6063-T5
Surface: Silver / black / white Anodized
PC cover: Milky white/black/acrylic matte
Apply: LED Strips and PCB 9.9mm

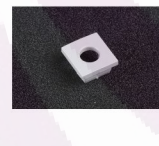
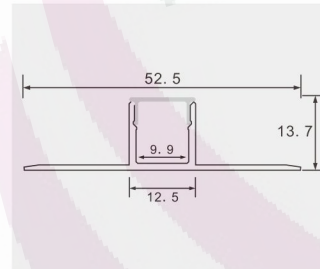

塑料堵头
plastic end cap

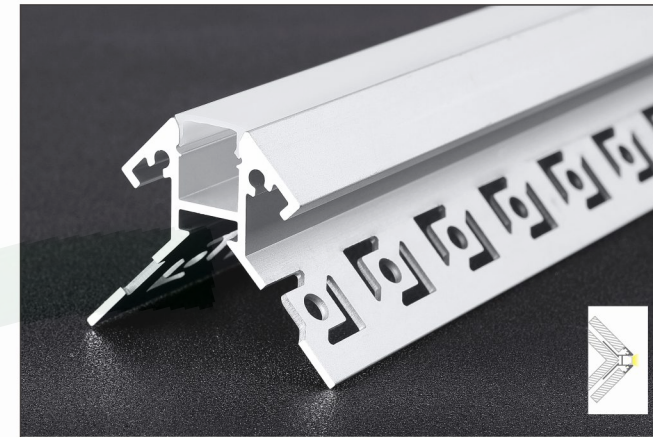

707阳角

产品参数

尺寸: Lx41.3x41.3mm
材质: 6063-T5 铝合金
表面: 氧化铝本色/喷漆 (黑色/白色)
PC罩: 乳白/黑色/亚克力磨砂可选
适用: 9MM软灯带/硬灯条

Description

size: Lx41.3x41.3mm
Material: 6063-T5
Surface: Silver / black / white Anodized
PC cover: Milky white/black/acrylic matte
Apply: LED Strips and PCB 9mm

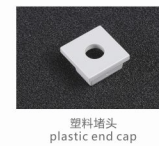
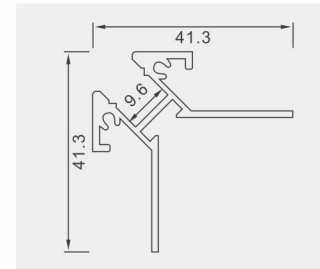

塑料堵头
plastic end cap



707阴角

产品参数

尺寸: Lx41.3x41.3mm
材质: 6063-T5 铝合金
表面: 氧化铝本色/喷漆 (黑色/白色)
PC罩: 乳白/黑色/亚克力磨砂可选
适用: 9MM软灯带/硬灯条

Description

size: Lx41.3x41.3mm
Material: 6063-T5
Surface: Silver / black / white Anodized
PC cover: Milky white/black/acrylic matte
Apply: LED Strips and PCB 9mm

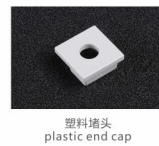
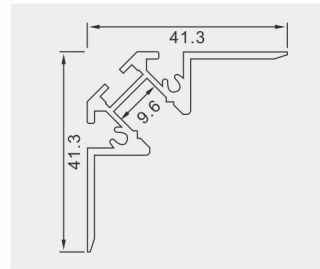

塑料堵头
plastic end cap



601花边

产品参数

尺寸: Lx36x36mm
材质: 6063-T5 铝合金
表面: 氧化铝本色/喷漆 (黑色/白色)
PC罩: 乳白/黑色/亚克力磨砂可选
适用: 8MM软灯带/硬灯条

Description

size: Lx36x36mm
Material: 6063-T5
Surface: Silver / black / white Anodized
PC cover: Milky white/black/acrylic matte
Apply: LED Strips and PCB 8mm

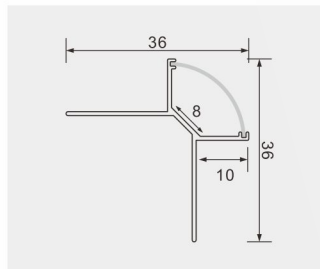

塑料堵头
plastic end cap



613花边

产品参数

尺寸: Lx52.5x14.4mm
材质: 6063-T5 铝合金
表面: 氧化铝本色/喷漆 (黑色/白色)
PC罩: 乳白/黑色/亚克力磨砂可选
适用: 12MM软灯带/硬灯条

Description

size: Lx52.5x14.4mm
Material: 6063-T5
Surface: Silver / black / white Anodized
PC cover: Milky white/black/acrylic matte
Apply: LED Strips and PCB 12mm

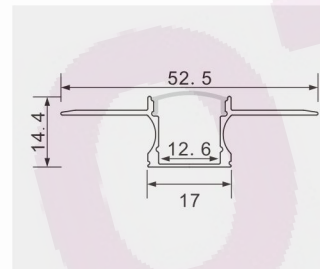

塑料堵头
plastic end cap

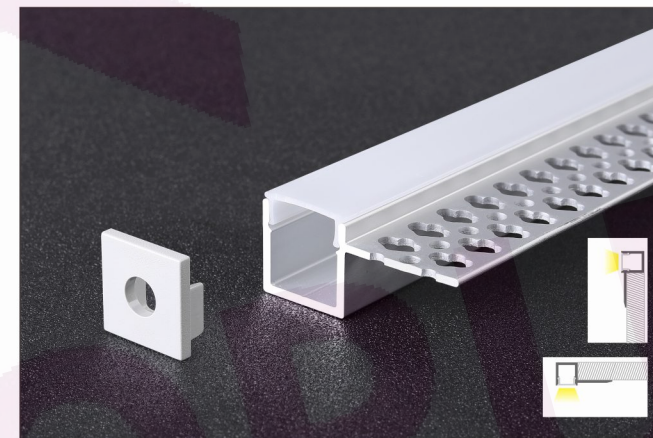

701米字

产品参数

尺寸: Lx35.5x15mm
材质: 6063-T5 铝合金
表面: 氧化铝本色/喷漆 (黑色/白色)
PC罩: 乳白/黑色/亚克力磨砂可选
适用: 12MM软灯带/硬灯条

Description

size: Lx35.5x15mm
Material: 6063-T5
Surface: Silver / black / white Anodized
PC cover: Milky white/black/acrylic matte
Apply: LED Strips and PCB 12mm

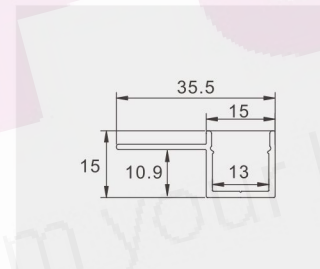

塑料堵头
plastic end cap

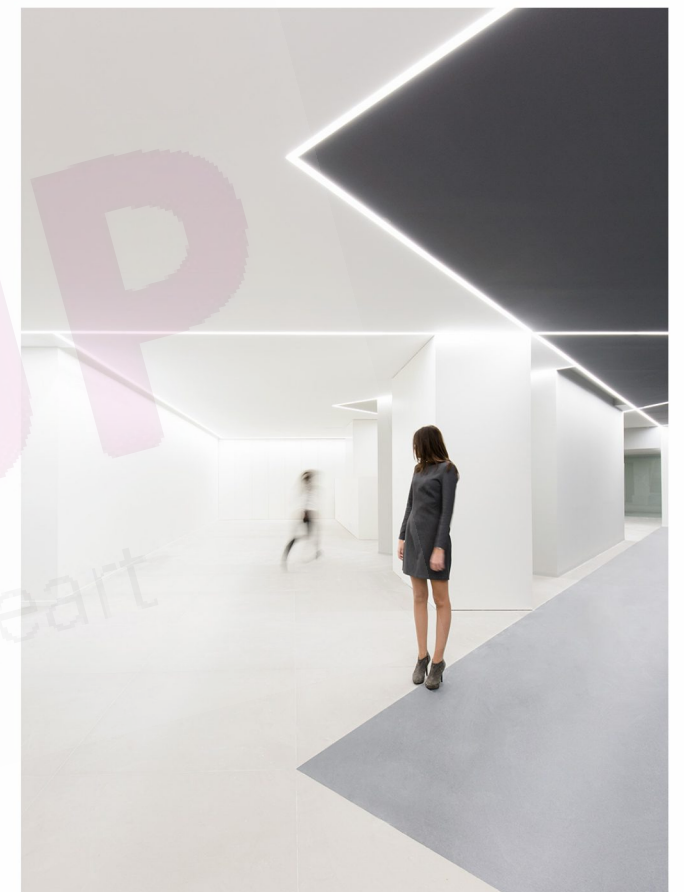

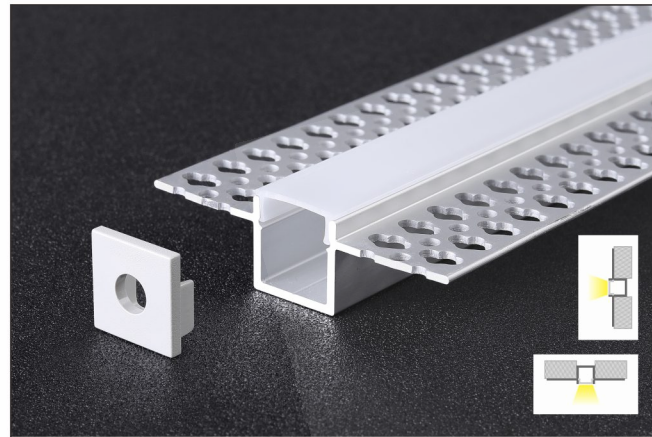

639米字

产品参数

尺寸: Lx56x15mm
材质: 6063-T5 铝合金
表面: 氧化铝本色/喷漆 (黑色/白色)
PC罩: 乳白/黑色/亚克力磨砂可选
适用: 12MM软灯带/硬灯条

Description

size: Lx56x15mm
Material: 6063-T5
Surface: Silver / black / white Anodized
PC cover: Milky white/black/acrylic matte
Apply: LED Strips and PCB 12mm

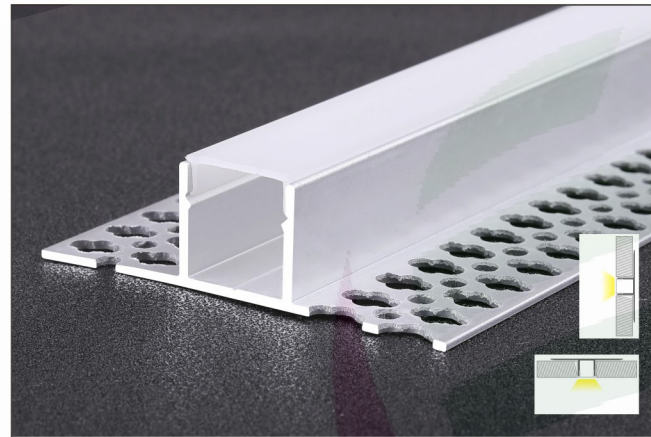
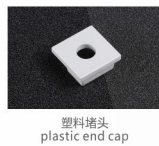
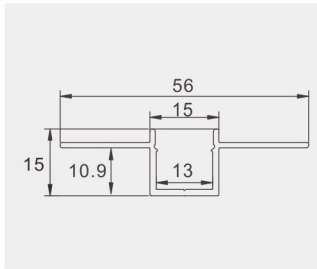

639米字下花边

产品参数

尺寸: Lx55.5x15.7mm
材质: 6063-T5 铝合金
表面: 氧化铝本色/喷漆 (黑色/白色)
PC罩: 乳白/黑色/亚克力磨砂可选
适用: 12MM软灯带/硬灯条

Description

size: Lx55.5x15.7mm
Material: 6063-T5
Surface: Silver / black / white Anodized
PC cover: Milky white/black/acrylic matte
Apply: LED Strips and PCB 12mm

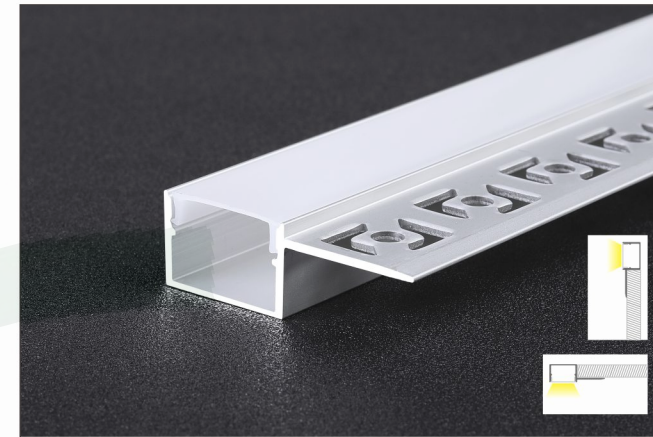
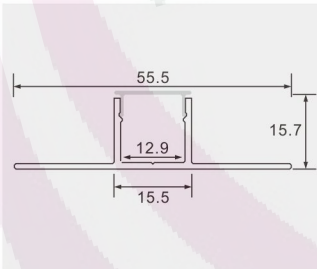

2013单花边

产品参数

尺寸: Lx40x13mm
材质: 6063-T5 铝合金
表面: 氧化铝本色/喷漆 (黑色/白色)
PC罩: 乳白/黑色/亚克力磨砂可选
适用: 17.5MM软灯带/硬灯条

Description

size: Lx40x13mm
Material: 6063-T5
Surface: Silver / black / white Anodized
PC cover: Milky white/black/acrylic matte
Apply: LED Strips and PCB 17.5mm

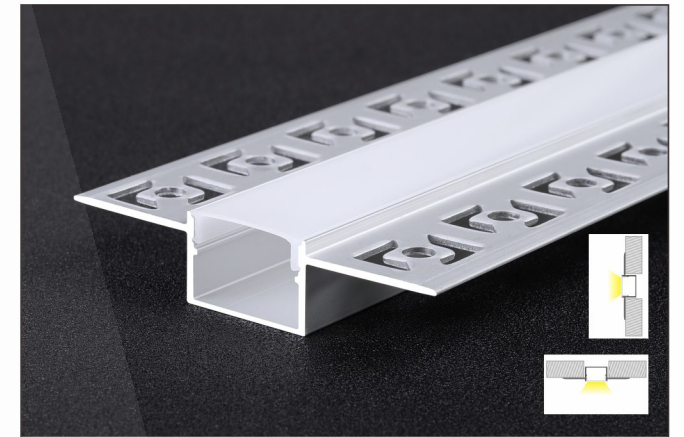
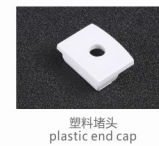
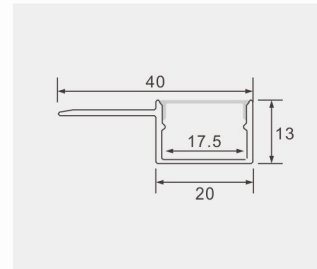

2013上花边

产品参数

尺寸: Lx60x13mm
材质: 6063-T5 铝合金
表面: 氧化铝本色/喷漆 (黑色/白色)
PC罩: 乳白/黑色/亚克力磨砂可选
适用: 17.5MM软灯带/硬灯条

Description

size: Lx60x13mm
Material: 6063-T5
Surface: Silver / black / white Anodized
PC cover: Milky white/black/acrylic matte
Apply: LED Strips and PCB 17.5mm

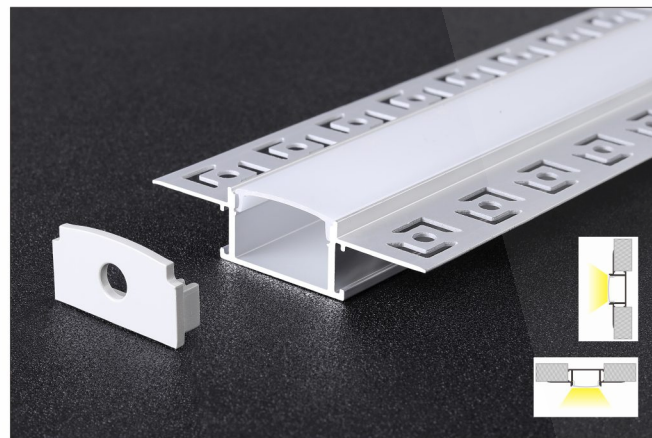
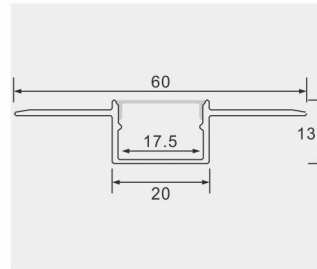

6114

产品参数

尺寸: Lx61x14mm
材质: 6063-T5 铝合金
表面: 氧化铝本色/喷漆 (黑色/白色)
PC罩: 乳白/黑色/亚克力磨砂可选
适用: 20MM软灯带/硬灯条

Description

size: Lx61x14mm
Material: 6063-T5
Surface: Silver / black / white Anodized
PC cover: Milky white/black/acrylic matte
Apply: LED Strips and PCB 20mm

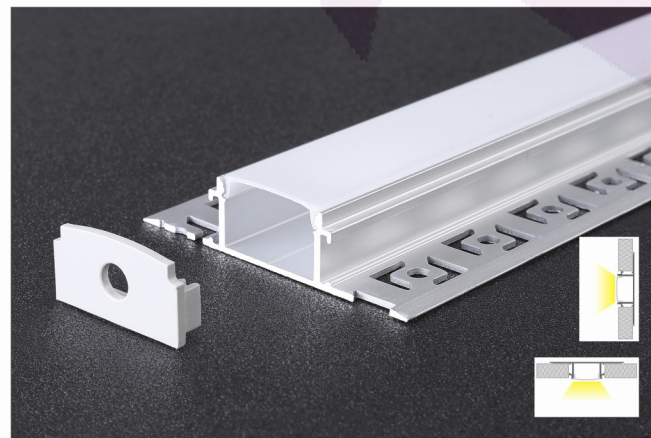
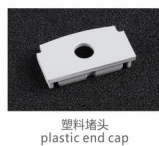
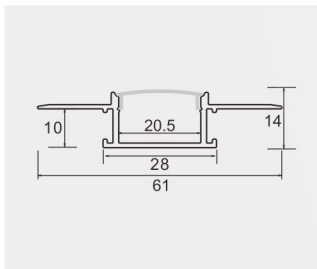

6114A

产品参数

尺寸: Lx61x14mm
材质: 6063-T5 铝合金
表面: 氧化铝本色/喷漆 (黑色/白色)
PC罩: 乳白/黑色/亚克力磨砂可选
适用: 20MM软灯带/硬灯条

Description

size: Lx61x14mm
Material: 6063-T5
Surface: Silver / black / white Anodized
PC cover: Milky white/black/acrylic matte
Apply: LED Strips and PCB 20mm

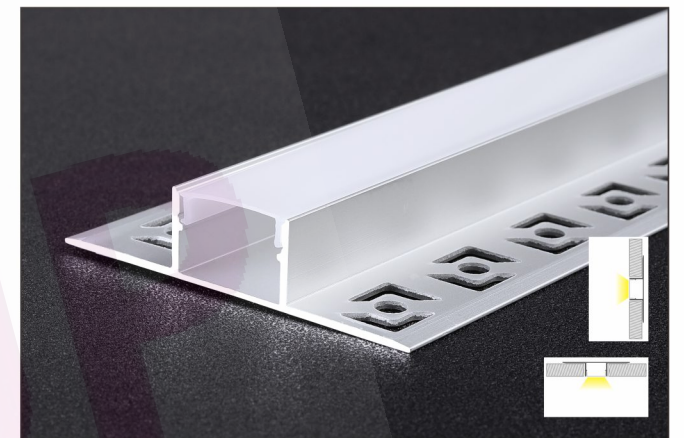
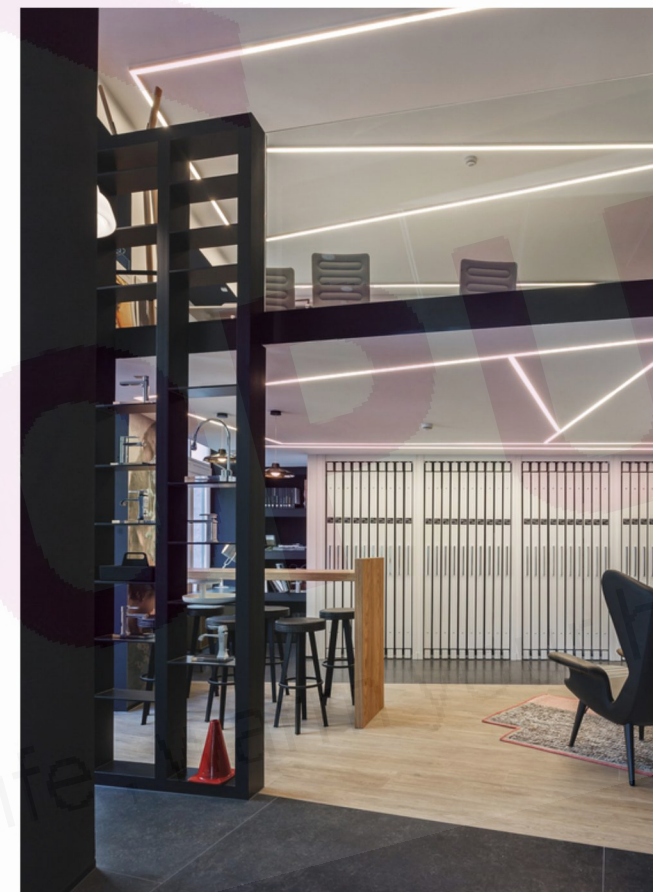
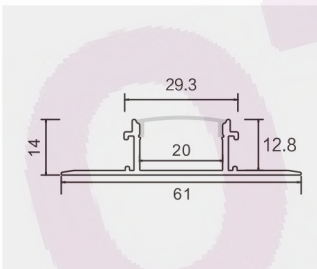

2013下花边

产品参数

尺寸: Lx60x13mm
材质: 6063-T5 铝合金
表面: 氧化铝本色/喷漆 (黑色/白色)
PC罩: 乳白/黑色/亚克力磨砂可选
适用: 17.5MM软灯带/硬灯条

Description

size: Lx60x13mm
Material: 6063-T5
Surface: Silver / black / white Anodized
PC cover: Milky white/black/acrylic matte
Apply: LED Strips and PCB 17.5mm

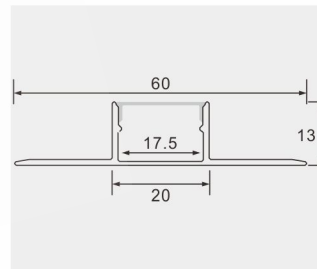



3020单花边

产品参数
尺寸: Lx50x20mm
材质: 6063-T5 铝合金
表面: 氧化铝本色/喷漆 (黑色/白色)
PC罩: 乳白/黑色/亚克力磨砂可选
适用: 28MM软灯带/硬灯条

Description
size: Lx50x20mm
Material: 6063-T5
Surface: Silver / black / white Anodized
PC cover: Milky white/black/acrylic matte
Apply: LED Strips and PCB 28mm

塑料堵头
plastic end cap

3020上花边

产品参数
尺寸: Lx70x20mm
材质: 6063-T5 铝合金
表面: 氧化铝本色/喷漆 (黑色/白色)
PC罩: 乳白/黑色/亚克力磨砂可选
适用: 28MM软灯带/硬灯条

Description
size: Lx70x20mm
Material: 6063-T5
Surface: Silver / black / white Anodized
PC cover: Milky white/black/acrylic matte
Apply: LED Strips and PCB 28mm

塑料堵头
plastic end cap

9620

产品参数
尺寸: Lx96x20mm
材质: 6063-T5 铝合金
表面: 氧化铝本色/喷漆 (黑色/白色)
PC罩: 乳白/黑色/亚克力磨砂可选
适用: 45MM软灯带/硬灯条

Description
size: Lx96x20mm
Material: 6063-T5
Surface: Silver / black / white Anodized
PC cover: Milky white/black/acrylic matte
Apply: LED Strips and PCB 45mm

塑料堵头
plastic end cap

踩地线条灯

铝型材套件

»»» P50-P52



2023
NEW STYLE

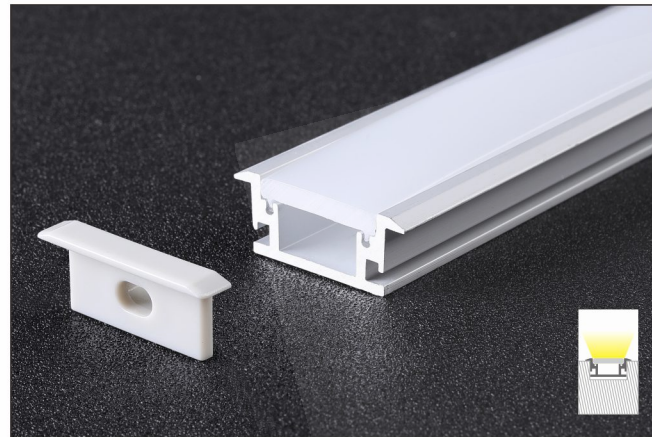

632-1

产品参数

尺寸: Lx28x11mm
材质: 6063-T5 铝合金
表面: 氧化铝本色/喷漆 (黑色/白色)
PC罩: 乳白/黑色/亚克力磨砂可选
适用: 12MM软灯带/硬灯条

Description

size: Lx28x11mm
Material: 6063-T5
Surface: Silver / black / white Anodized
PC cover: Milky white/black/acrylic matte
Apply: LED Strips and PCB 12mm

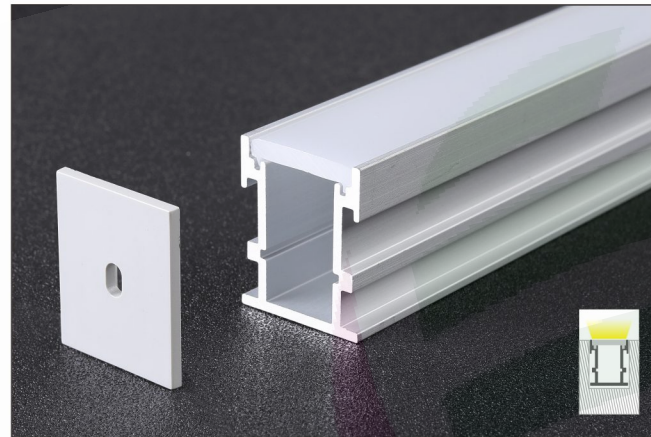
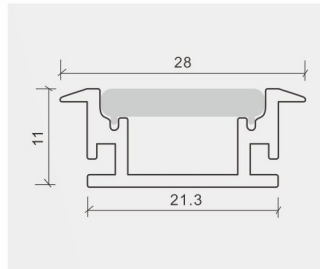

632

产品参数

尺寸: Lx21.3x25.8mm
材质: 6063-T5 铝合金
表面: 氧化铝本色/喷漆 (黑色/白色)
PC罩: 乳白/黑色/亚克力磨砂可选
适用: 12MM软灯带/硬灯条

Description

size: Lx21.3x25.8mm
Material: 6063-T5
Surface: Silver / black / white Anodized
PC cover: Milky white/black/acrylic matte
Apply: LED Strips and PCB 12mm

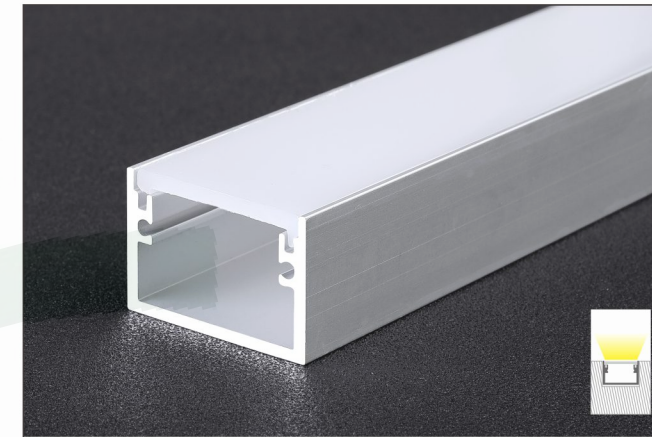
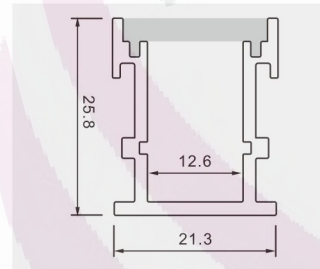

地踩3020M

产品参数

尺寸: Lx30x20mm
材质: 6063-T5 铝合金
表面: 氧化铝本色/喷漆 (黑色/白色)
PC罩: 乳白/黑色/亚克力磨砂可选
适用: 26MM软灯带/硬灯条

Description

size: Lx30x20mm
Material: 6063-T5
Surface: Silver / black / white Anodized
PC cover: Milky white/black/acrylic matte
Apply: LED Strips and PCB 26mm

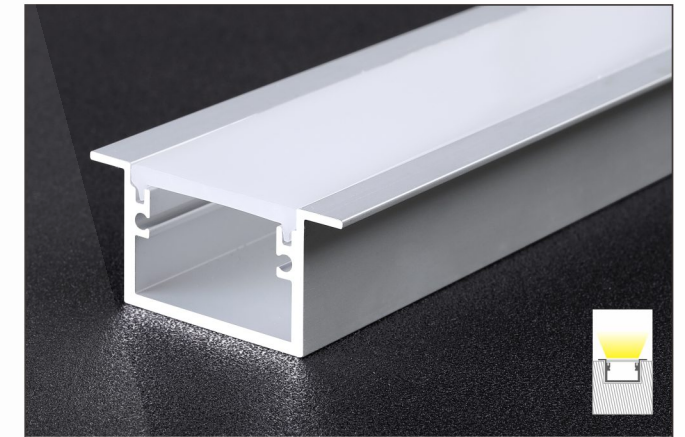
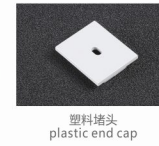
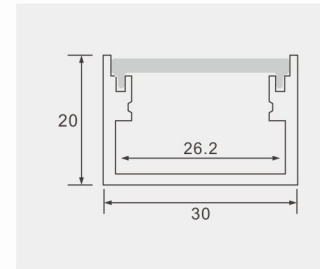

地踩3020A

产品参数

尺寸: Lx42x20mm
材质: 6063-T5 铝合金
表面: 氧化铝本色/喷漆 (黑色/白色)
PC罩: 乳白/黑色/亚克力磨砂可选
适用: 26MM软灯带/硬灯条

Description

size: Lx42x20mm
Material: 6063-T5
Surface: Silver / black / white Anodized
PC cover: Milky white/black/acrylic matte
Apply: LED Strips and PCB 26mm

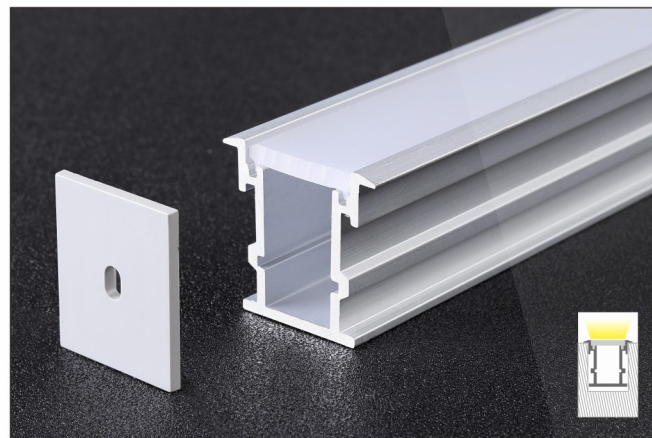
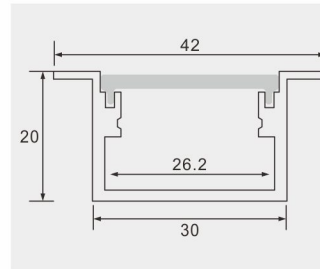

632A

产品参数

尺寸: Lx28x25.8mm
材质: 6063-T5 铝合金
表面: 氧化铝本色/喷漆 (黑色/白色)
PC罩: 乳白/黑色/亚克力磨砂可选
适用: 12MM软灯带/硬灯条

Description

size: Lx28x25.8mm
Material: 6063-T5
Surface: Silver / black / white Anodized
PC cover: Milky white/black/acrylic matte
Apply: LED Strips and PCB 12mm

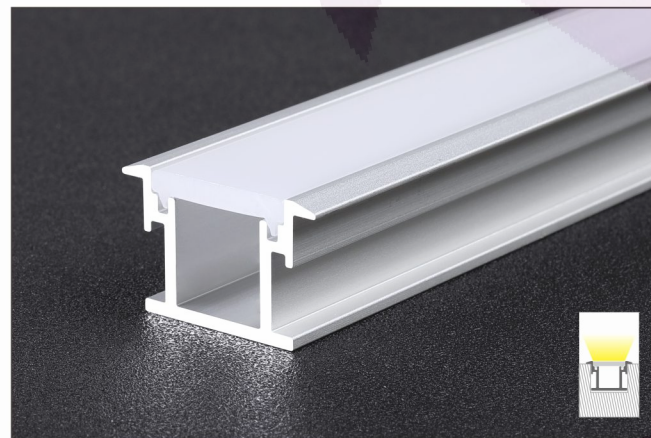
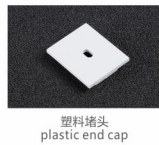
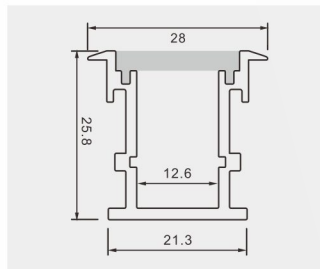

633

产品参数

尺寸: Lx27.5x17.5mm
材质: 6063-T5 铝合金
表面: 氧化铝本色/喷漆 (黑色/白色)
PC罩: 乳白/黑色/亚克力磨砂可选
适用: 12MM软灯带/硬灯条

Description

size: Lx27.5x17.5mm
Material: 6063-T5
Surface: Silver / black / white Anodized
PC cover: Milky white/black/acrylic matte
Apply: LED Strips and PCB 12mm

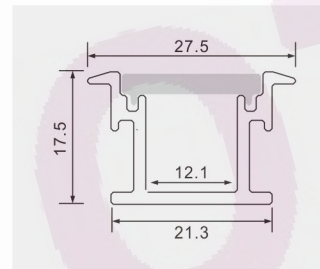

地踩5032M

产品参数

尺寸: Lx50x32.8mm
材质: 6063-T5 铝合金
表面: 氧化铝本色/喷漆 (黑色/白色)
PC罩: 乳白/黑色/亚克力磨砂可选
适用: 45MM软灯带/硬灯条

Description

size: Lx50x32.8mm
Material: 6063-T5
Surface: Silver / black / white Anodized
PC cover: Milky white/black/acrylic matte
Apply: LED Strips and PCB 45mm

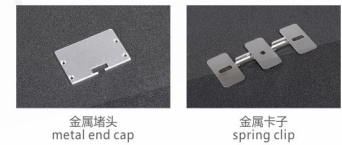
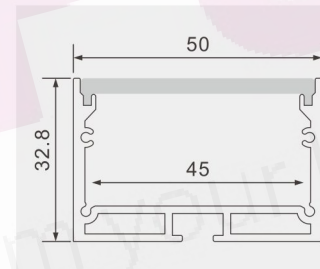

地踩5032A

产品参数

尺寸: Lx62.4x33mm
材质: 6063-T5 铝合金
表面: 氧化铝本色/喷漆 (黑色/白色)
PC罩: 乳白/黑色/亚克力磨砂可选
适用: 41MM软灯带/硬灯条

Description

size: Lx62.4x33mm
Material: 6063-T5
Surface: Silver / black / white Anodized
PC cover: Milky white/black/acrylic matte
Apply: LED Strips and PCB 41mm

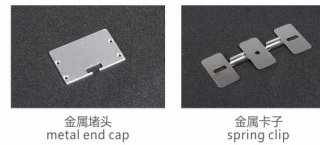
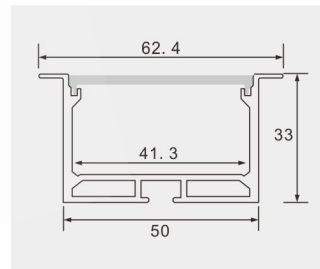

洗墙系列 铝型材套件

»» P53-P59

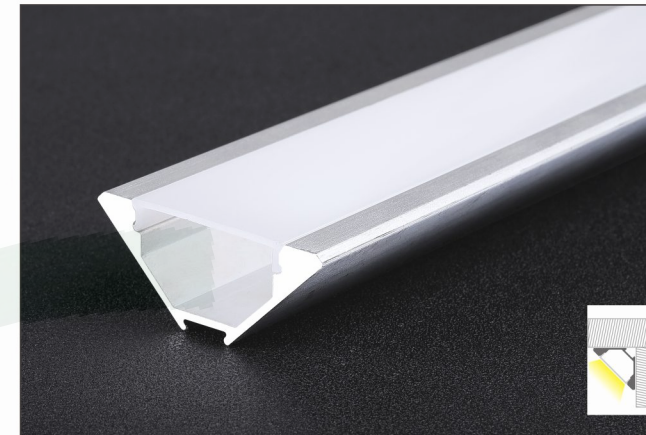

3030-L

产品参数

尺寸: Lx30x30mm
材质: 6063-T5 铝合金
表面: 氧化铝本色/喷漆 (黑色/白色)
PC罩: 乳白/黑色/亚克力磨砂可选
适用: 12MM软灯带/硬灯条

Description

size: Lx30x30mm
Material: 6063-T5
Surface: Silver / black / white Anodized
PC cover: Milky white/black/acrylic matte
Apply: LED Strips and PCB 12mm

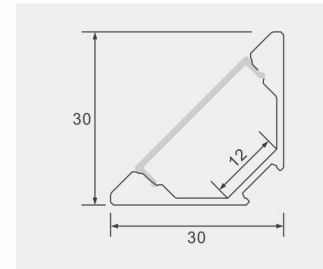

5050-L

产品参数

尺寸: Lx50x50mm
材质: 6063-T5 铝合金
表面: 氧化铝本色/喷漆 (黑色/白色)
PC罩: 乳白/黑色/亚克力磨砂可选
适用: 24MM软灯带/硬灯条

Description

size: Lx50x50mm
Material: 6063-T5
Surface: Silver / black / white Anodized
PC cover: Milky white/black/acrylic matte
Apply: LED Strips and PCB 24mm

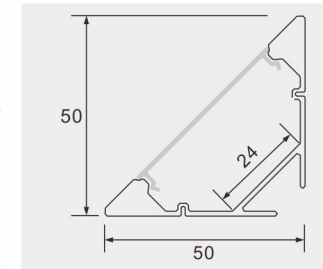

5050-X

产品参数

尺寸: Lx70.3x24.3mm
材质: 6063-T5 铝合金
表面: 氧化铝本色/喷漆 (黑色/白色)
PC罩: 乳白/黑色/亚克力磨砂可选
适用: 24MM软灯带/硬灯条

Description

size: Lx70.3x24.3mm
Material: 6063-T5
Surface: Silver / black / white Anodized
PC cover: Milky white/black/acrylic matte
Apply: LED Strips and PCB 24mm

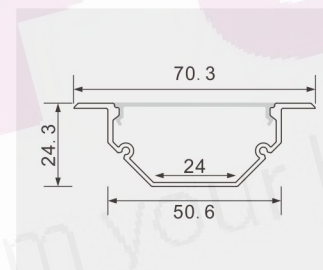

8080-X

产品参数

尺寸: Lx100x32.6mm
材质: 6063-T5 铝合金
表面: 氧化铝本色/喷漆 (黑色/白色)
PC罩: 乳白/黑色/亚克力磨砂可选
适用: 38MM软灯带/硬灯条

Description

size: Lx100x32.6mm
Material: 6063-T5
Surface: Silver / black / white Anodized
PC cover: Milky white/black/acrylic matte
Apply: LED Strips and PCB 38mm

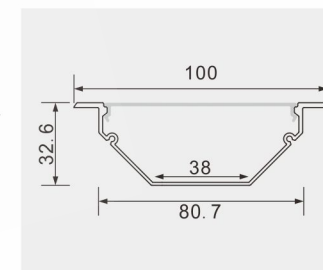

2023
NEW STYLE



101

产品参数

尺寸: Lx43.8x21.3mm
材质: 6063-T5 铝合金
表面: 氧化铝本色/喷漆 (黑色/白色)
PC罩: 乳白/黑色/亚克力磨砂可选
适用: 17MM软灯带/硬灯条

Description

size: Lx43.8x21.3mm
Material: 6063-T5
Surface: Silver / black / white Anodized
PC cover: Milky white/black/acrylic matte
Apply: LED Strips and PCB 17mm

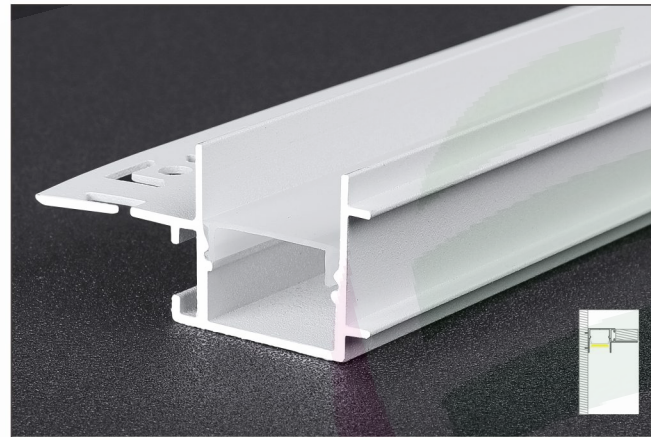
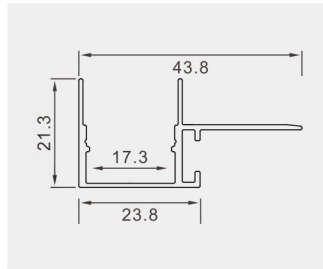

新款101

产品参数

尺寸: Lx46.9x21.4mm
材质: 6063-T5 铝合金
表面: 氧化铝本色/喷漆 (黑色/白色)
PC罩: 乳白/黑色/亚克力磨砂可选
适用: 17MM软灯带/硬灯条

Description

size: Lx46.9x21.4mm
Material: 6063-T5
Surface: Silver / black / white Anodized
PC cover: Milky white/black/acrylic matte
Apply: LED Strips and PCB 17mm

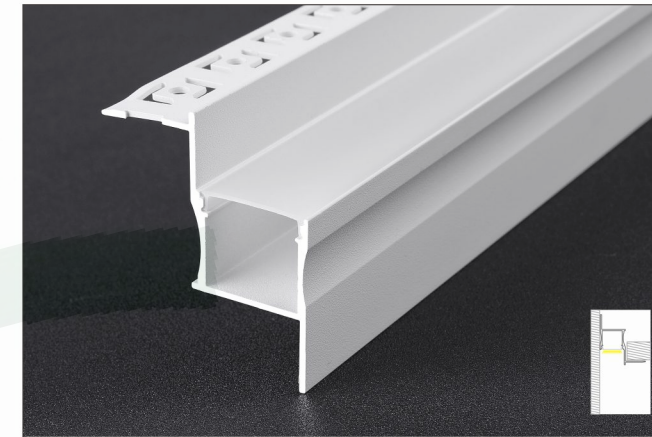
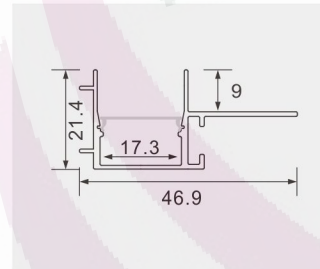

103

产品参数

尺寸: Lx45.2x50mm
材质: 6063-T5 铝合金
表面: 氧化铝本色/喷漆 (黑色/白色)
PC罩: 乳白/黑色/亚克力磨砂可选
适用: 20MM软灯带/硬灯条

Description

size: Lx45.2x50mm
Material: 6063-T5
Surface: Silver / black / white Anodized
PC cover: Milky white/black/acrylic matte
Apply: LED Strips and PCB 20mm

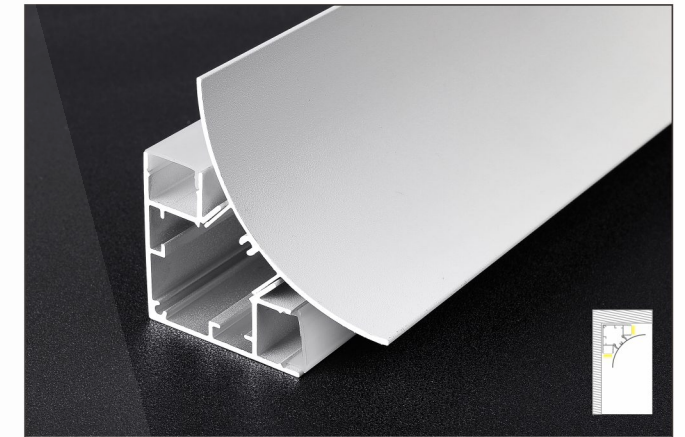
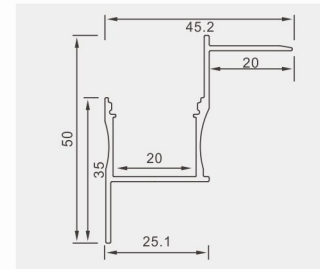

104

产品参数

尺寸: Lx60x60mm
材质: 6063-T5 铝合金
表面: 氧化铝本色/喷漆 (黑色/白色)
PC罩: 乳白/黑色/亚克力磨砂可选
适用: 12MM软灯带/硬灯条

Description

size: Lx60x60mm
Material: 6063-T5
Surface: Silver / black / white Anodized
PC cover: Milky white/black/acrylic matte
Apply: LED Strips and PCB 12mm

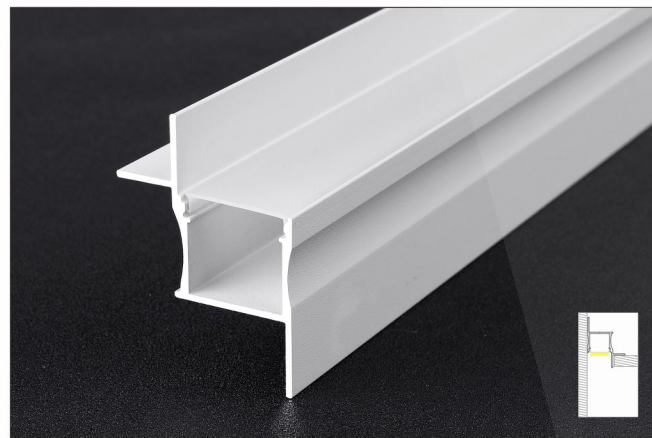
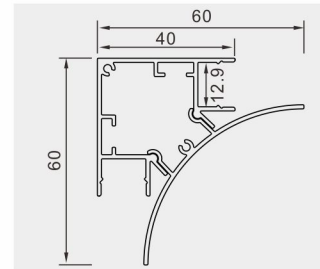

102

产品参数

尺寸: Lx37x50mm
材质: 6063-T5 铝合金
表面: 氧化铝本色/喷漆 (黑色/白色)
PC罩: 乳白/黑色/亚克力磨砂可选
适用: 20MM软灯带/硬灯条

Description

size: Lx37x50mm
Material: 6063-T5
Surface: Silver / black / white Anodized
PC cover: Milky white/black/acrylic matte
Apply: LED Strips and PCB 20mm

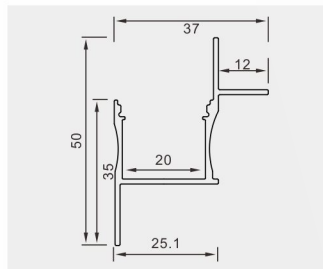

105

产品参数

尺寸: Lx86x23mm
材质: 6063-T5 铝合金
表面: 氧化铝本色/喷漆 (黑色/白色)
PC罩: 乳白/黑色/亚克力磨砂可选
适用: 21MM软灯带/硬灯条

Description

size: Lx86x23mm
Material: 6063-T5
Surface: Silver / black / white Anodized
PC cover: Milky white/black/acrylic matte
Apply: LED Strips and PCB 21mm

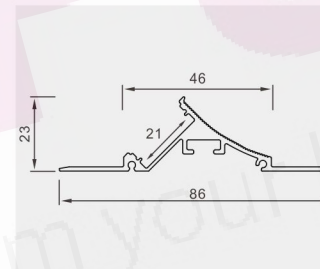

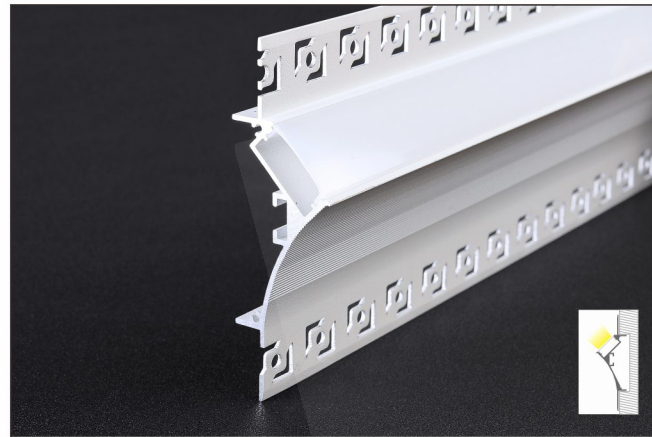

801

产品参数

尺寸: Lx95x30mm
材质: 6063-T5 铝合金
表面: 氧化铝本色/喷漆 (黑色/白色)
PC罩: 乳白/黑色/亚克力磨砂可选
适用: 21MM软灯带/硬灯条

Description

size: Lx95x30mm
Material: 6063-T5
Surface: Silver / black / white Anodized
PC cover: Milky white/black/acrylic matte
Apply: LED Strips and PCB 21mm

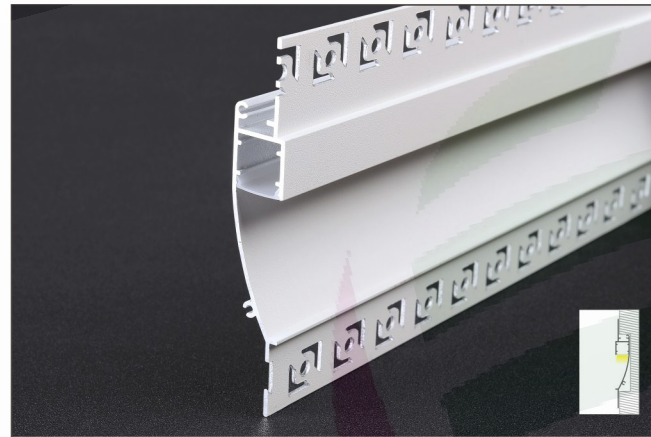
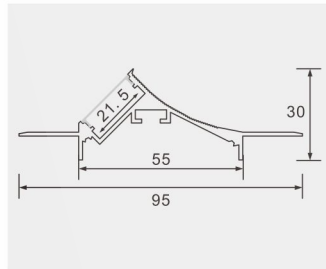

803

产品参数

尺寸: Lx96x15.3mm
材质: 6063-T5 铝合金
表面: 氧化铝本色/喷漆 (黑色/白色)
PC罩: 乳白/黑色/亚克力磨砂可选
适用: 12MM软灯带/硬灯条

Description

size: Lx96x15.3mm
Material: 6063-T5
Surface: Silver / black / white Anodized
PC cover: Milky white/black/acrylic matte
Apply: LED Strips and PCB 12mm

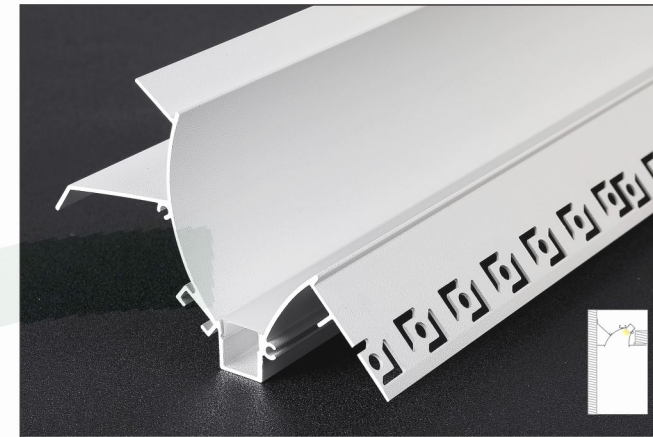
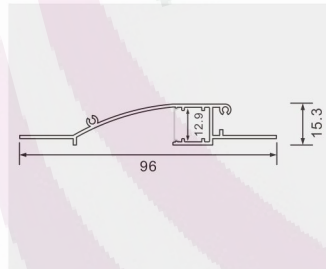

107

产品参数

尺寸: Lx88x50mm
材质: 6063-T5 铝合金
表面: 氧化铝本色/喷漆 (黑色/白色)
PC罩: 乳白/黑色/亚克力磨砂可选
适用: 10MM软灯带/硬灯条

Description

size: Lx88x50mm
Material: 6063-T5
Surface: Silver / black / white Anodized
PC cover: Milky white/black/acrylic matte
Apply: LED Strips and PCB 10mm

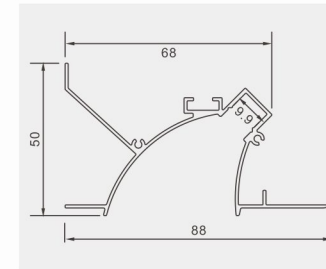

弧形花边

产品参数

尺寸: Lx88.5x58.6mm
材质: 6063-T5 铝合金
表面: 氧化铝本色/喷漆 (黑色/白色)
PC罩: 乳白/黑色/亚克力磨砂可选
适用: 21MM软灯带/硬灯条

Description

size: Lx88.5x58.6mm
Material: 6063-T5
Surface: Silver / black / white Anodized
PC cover: Milky white/black/acrylic matte
Apply: LED Strips and PCB 21mm

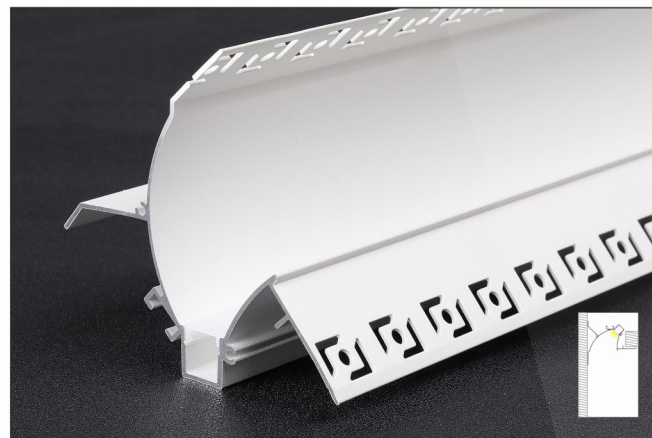
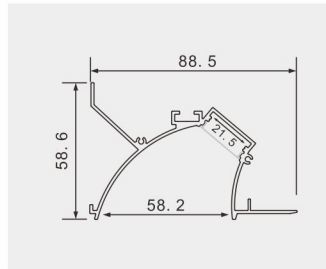

106

产品参数

尺寸: Lx78x70.3mm
材质: 6063-T5 铝合金
表面: 氧化铝本色/喷漆 (黑色/白色)
PC罩: 乳白/黑色/亚克力磨砂可选
适用: 10MM软灯带/硬灯条

Description

size: Lx78x70.3mm
Material: 6063-T5
Surface: Silver / black / white Anodized
PC cover: Milky white/black/acrylic matte
Apply: LED Strips and PCB 10mm

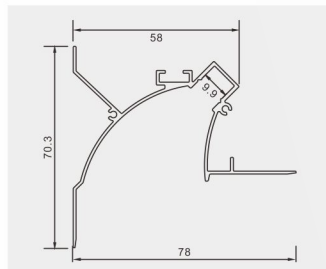

弧形预埋

产品参数

尺寸: Lx90.7x58.7mm
材质: 6063-T5 铝合金
表面: 氧化铝本色/喷漆 (黑色/白色)
PC罩: 乳白/黑色/亚克力磨砂可选
适用: 20MM软灯带/硬灯条

Description

size: Lx90.7x58.7mm
Material: 6063-T5
Surface: Silver / black / white Anodized
PC cover: Milky white/black/acrylic matte
Apply: LED Strips and PCB 20mm

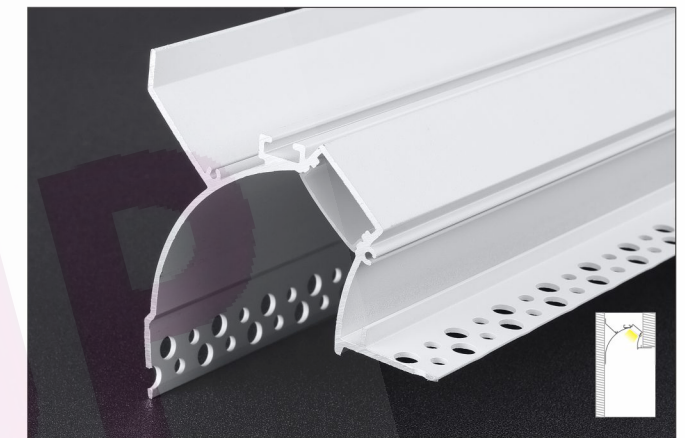
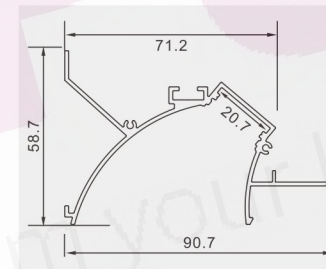

弧形花边加长款

产品参数

尺寸: Lx88.6x87mm
材质: 6063-T5 铝合金
表面: 氧化铝本色/喷漆 (黑色/白色)
PC罩: 乳白/黑色/亚克力磨砂可选
适用: 21MM软灯带/硬灯条

Description

size: Lx88.6x87mm
Material: 6063-T5
Surface: Silver / black / white Anodized
PC cover: Milky white/black/acrylic matte
Apply: LED Strips and PCB 21mm

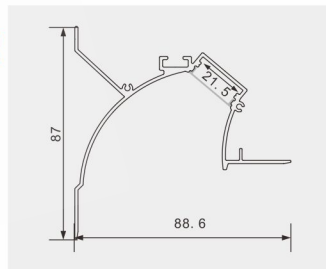

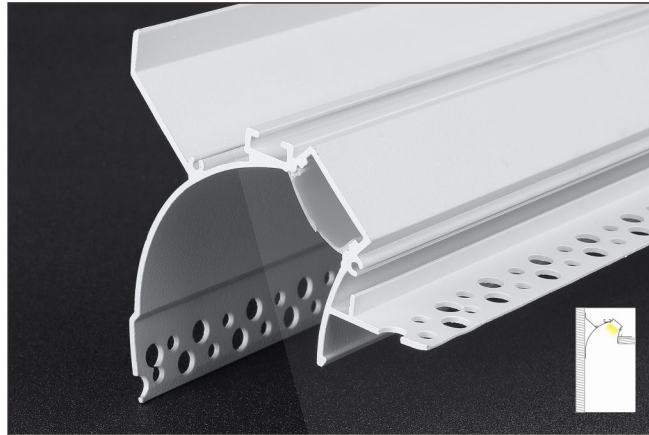

弧形预埋加长款

产品参数

尺寸: Lx88.6x87mm
材质: 6063-T5 铝合金
表面: 氧化铝本色/喷漆 (黑色/白色)
PC罩: 乳白/黑色/亚克力磨砂可选
适用: 21MM软灯带/硬灯条

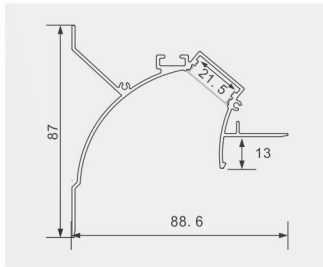

Description

size: Lx88.6x87mm
Material: 6063-T5
Surface: Silver / black / white Anodized
PC cover: Milky white/black/acrylic matte
Apply: LED Strips and PCB 21mm

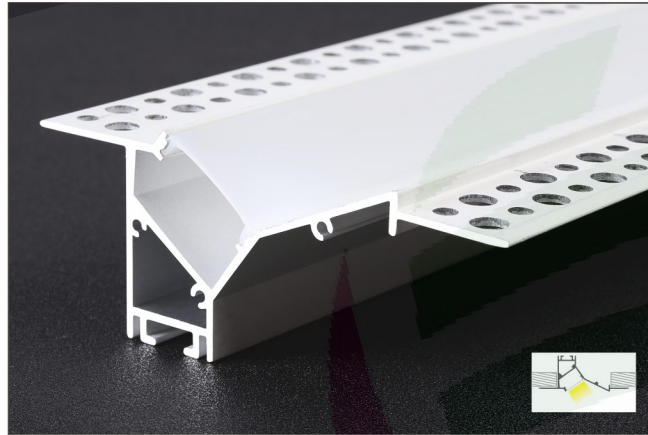

802

产品参数

尺寸: Lx95x38mm
材质: 6063-T5 铝合金
表面: 氧化铝本色/喷漆 (黑色/白色)
PC罩: 乳白/黑色/亚克力磨砂可选
适用: 21MM软灯带/硬灯条

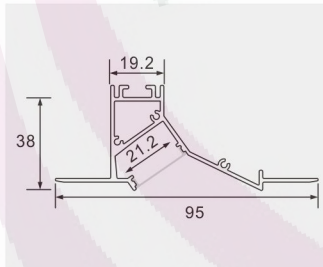

Description

size: Lx95x38mm
Material: 6063-T5
Surface: Silver / black / white Anodized
PC cover: Milky white/black/acrylic matte
Apply: LED Strips and PCB 21mm

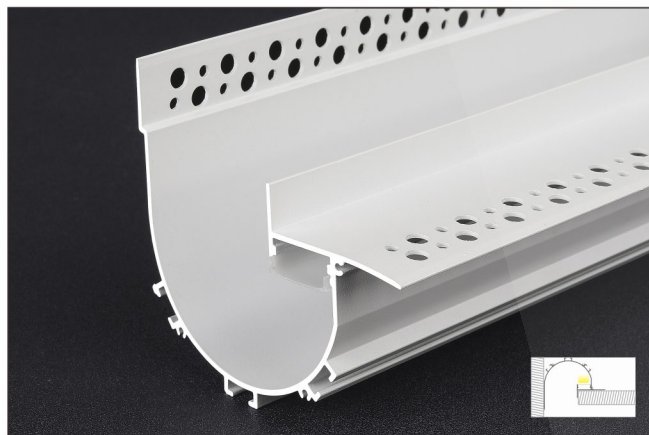

半圆回光槽

产品参数

尺寸: Lx101.4x86.5mm
材质: 6063-T5 铝合金
表面: 氧化铝本色/喷漆 (黑色/白色)
PC罩: 乳白/黑色/亚克力磨砂可选
适用: 21MM软灯带/硬灯条

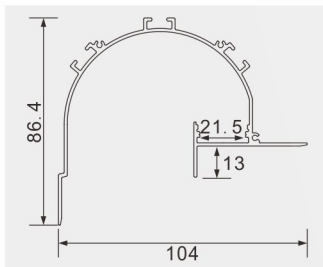

Description

size: Lx101.4x86.5mm
Material: 6063-T5
Surface: Silver / black / white Anodized
PC cover: Milky white/black/acrylic matte
Apply: LED Strips and PCB 21mm



磁吸灯 铝型材套件

»»» P60-P65



2023
NEW STYLE

折弯磁吸系列

最小折弯半径:内尺寸R>200MM



可定制弧度-泛光灯30CM



可定制弧度-泛光灯60CM



可定制弧度-格栅灯6瓦



可定制弧度-格栅灯12瓦



可定制弧度-轨道灯7瓦(圆)



可定制弧度-轨道灯12瓦(圆)



可拼接射灯1瓦



可定制弧度-磁吸灯内置电源



输入模块



转角模块



暗装轨道折弯

产品参数

尺寸: Lx49x53mm
材质: 6063-T5 铝合金
表面: 喷漆/氧化 黑色
适用: 2.0磁吸灯
最小拉弯半径:内尺寸R>200MM
拉弯方向: 侧弯

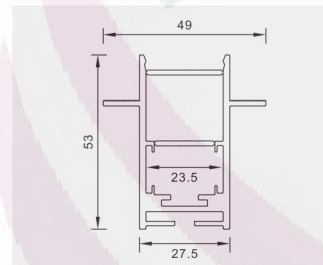

明装轨道折弯

产品参数

尺寸: Lx27.5x53mm
材质: 6063-T5 铝合金
表面: 喷漆/氧化 黑色
适用: 2.0磁吸灯
最小拉弯半径:内尺寸R>200MM
拉弯方向: 侧弯

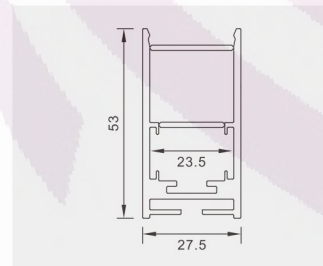

线性灯折弯 铝型材加工配套

》》》 P68-P74



2023
NEW STYLE

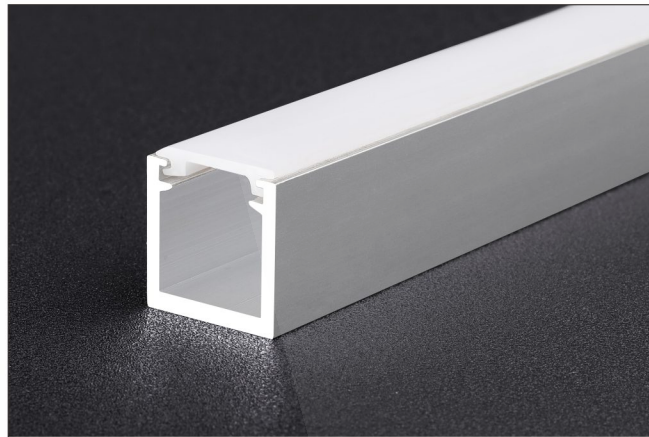

2020M折弯

产品参数

折弯线性灯

尺寸: Lx20x20mm
材质: 6063-T5 铝合金
表面: 氧化铝本色/喷漆 (黑色/白色)
灯罩: 硅胶面罩/亚克力
适用: 16MM软灯带/硬灯条
最小折弯半径: 内尺寸R> 200MM
折弯方向: 侧弯, 向下发光

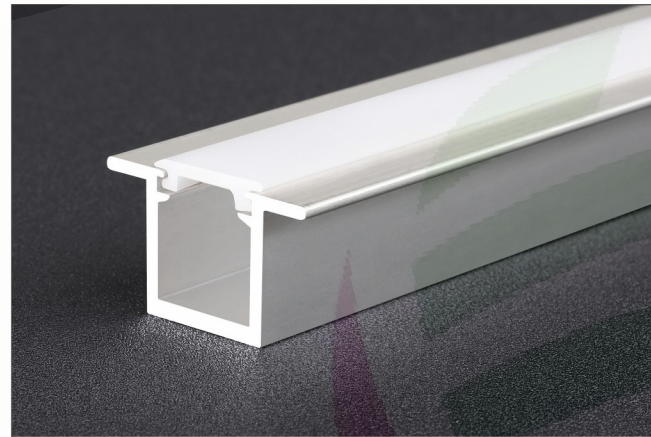
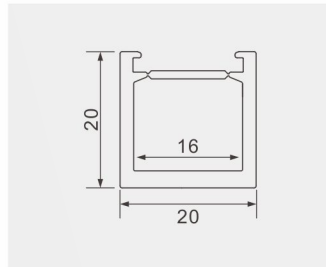

2020A折弯

产品参数

折弯线性灯

尺寸: Lx34x20mm
材质: 6063-T5 铝合金
表面: 氧化铝本色/喷漆 (黑色/白色)
灯罩: 硅胶面罩/亚克力
适用: 16MM软灯带/硬灯条
最小折弯半径: 内尺寸R> 200MM
折弯方向: 侧弯, 向下发光

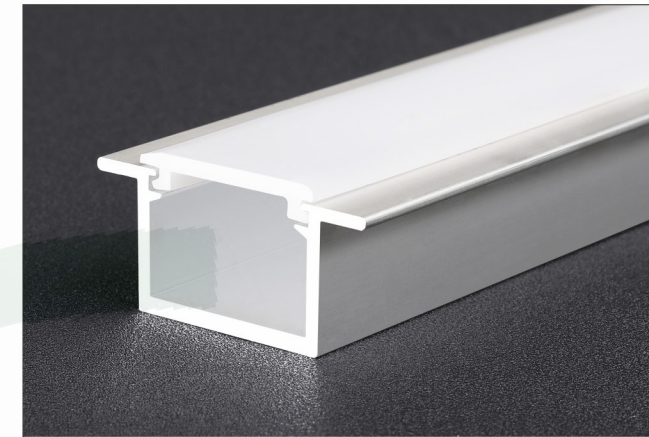
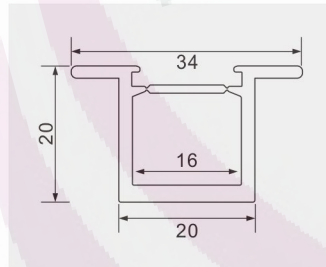

3020A折弯

产品参数

折弯线性灯

尺寸: Lx43.5x20mm
材质: 6063-T5 铝合金
表面: 氧化铝本色/喷漆 (黑色/白色)
灯罩: 硅胶面罩/亚克力
适用: 26MM软灯带/硬灯条
最小折弯半径: 内尺寸R> 200MM
折弯方向: 侧弯, 向下发光

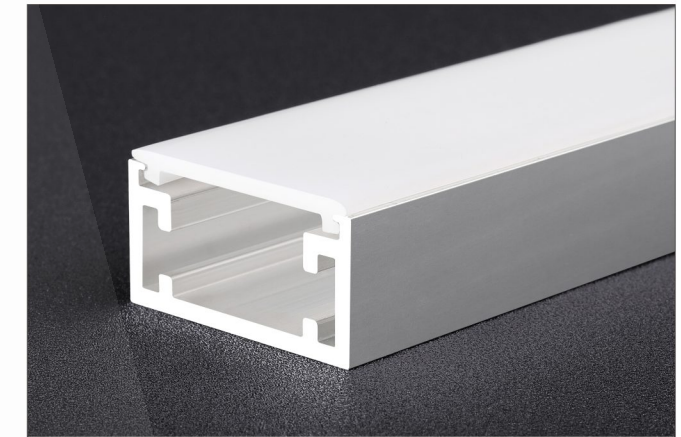
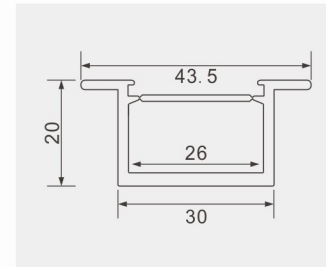

4020M折弯

产品参数

折弯线性灯

尺寸: Lx40x20mm
材质: 6063-T5 铝合金
表面: 氧化铝本色/喷漆 (黑色/白色)
灯罩: 硅胶面罩/亚克力
适用: 23MM软灯带/硬灯条
最小折弯半径: 内尺寸R> 200MM
折弯方向: 侧弯, 向下发光

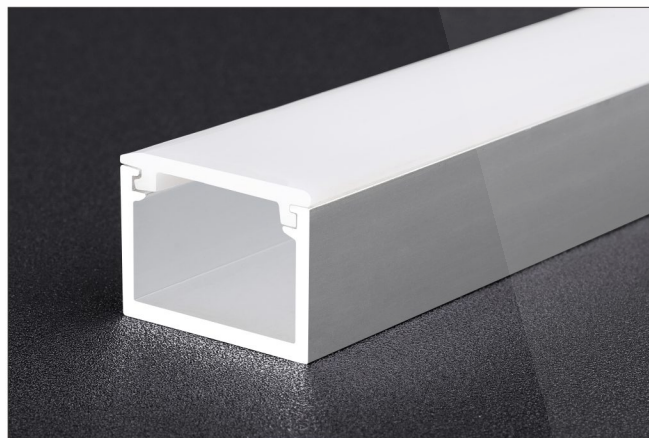
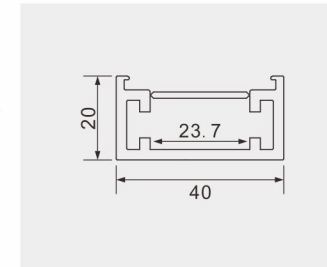

3020M折弯

产品参数

折弯线性灯

尺寸: Lx30x20mm
材质: 6063-T5 铝合金
表面: 氧化铝本色/喷漆 (黑色/白色)
灯罩: 硅胶面罩/亚克力
适用: 26MM软灯带/硬灯条
最小折弯半径: 内尺寸R> 200MM
折弯方向: 侧弯, 向下发光

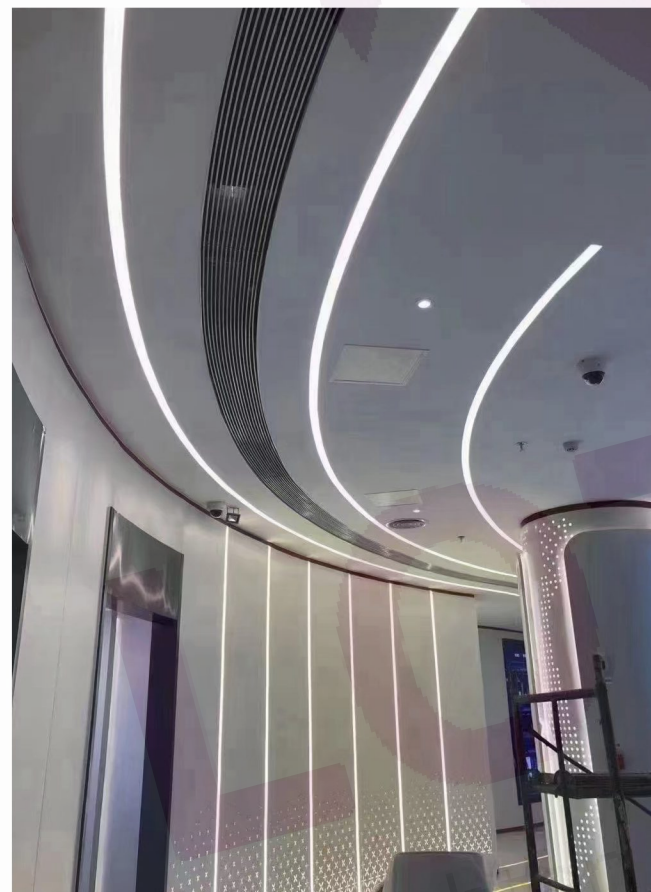
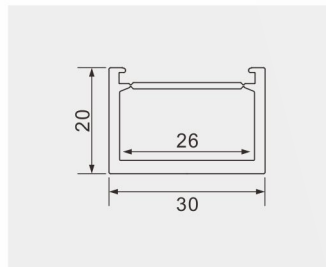

4020A折弯

产品参数

折弯线性灯

尺寸: Lx54x20mm
材质: 6063-T5 铝合金
表面: 氧化铝本色/喷漆 (黑色/白色)
灯罩: 硅胶面罩/亚克力
适用: 23MM软灯带/硬灯条
最小折弯半径: 内尺寸R> 200MM
折弯方向: 侧弯, 向下发光

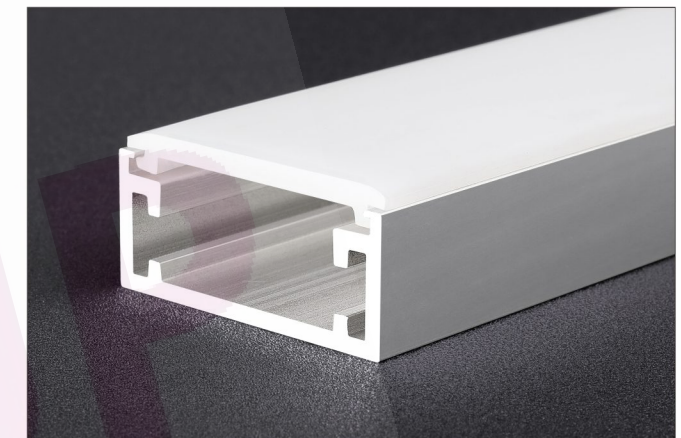
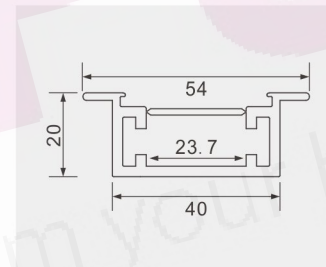

5020M折弯

产品参数

折弯线性灯

尺寸: Lx48x20mm
材质: 6063-T5 铝合金
表面: 氧化铝本色/喷漆 (黑色/白色)
灯罩: 硅胶面罩/亚克力
适用: 31MM软灯带/硬灯条
最小折弯半径: 内尺寸R> 200MM
折弯方向: 侧弯, 向下发光

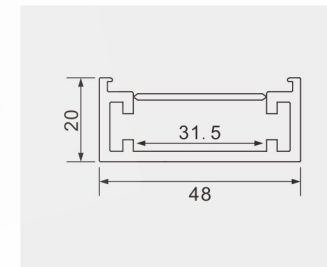

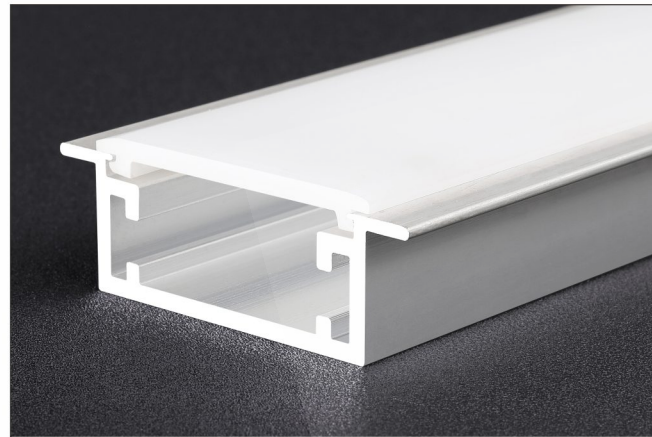

5020A折弯

产品参数

折弯线性灯

尺寸: Lx62x20mm
材质: 6063-T5 铝合金
表面: 氧化铝本色/喷漆 (黑色/白色)
灯罩: 硅胶面罩/亚克力
适用: 31MM软灯带/硬灯条
最小折弯半径: 内尺寸R > 200MM
拉弯方向: 侧弯, 向下发光

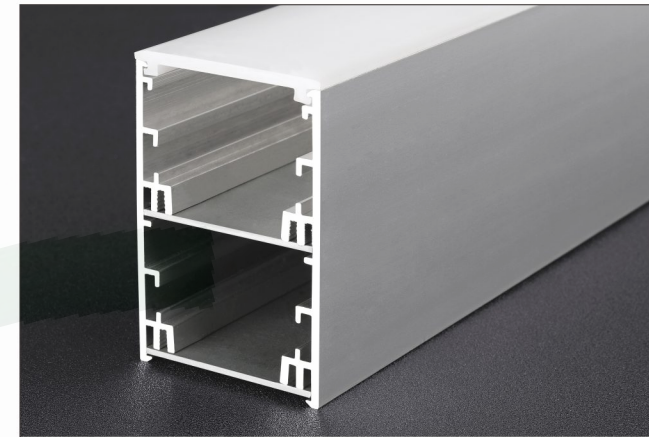
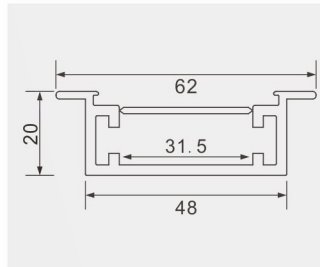

70M折弯

产品参数

明装组合款折弯线性灯

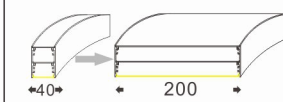

宽度可订制40-200MM*高度70MM
铝材和PC罩均为组合式安装, 宽度可订制, 可拆卸维护
最小拉弯半径: 内尺寸R > 200MM
材料长度: 3/6M
灯罩: 硅胶面罩/亚克力
拉弯方向: 侧弯下发光

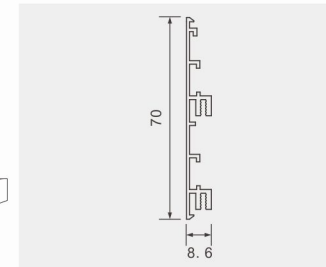

70A折弯

产品参数

嵌装组合款折弯线性灯

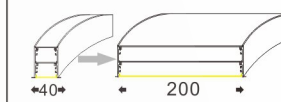

宽度可订制40-200MM*高度70MM
铝材和PC罩均为组合式安装, 宽度可订制, 可拆卸维护
最小拉弯半径: 内尺寸R > 200MM
材料长度: 3/6M
灯罩: 硅胶面罩/亚克力
拉弯方向: 侧弯下发光

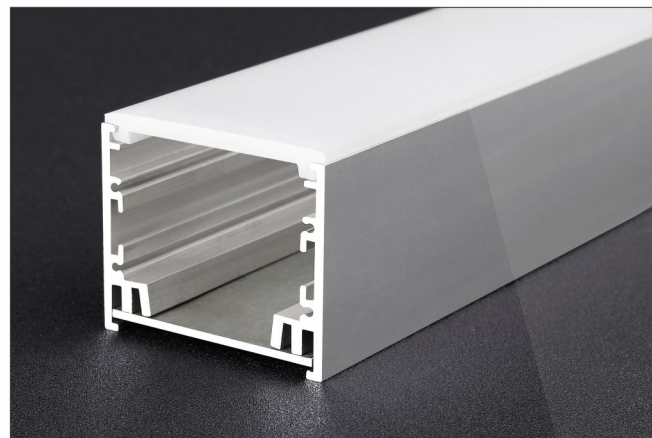
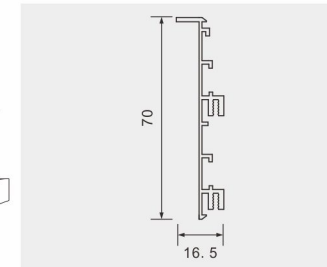

40M折弯

产品参数

明装组合款折弯线性灯

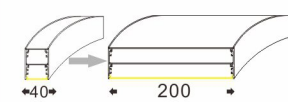

宽度可订制40-200MM*高度39MM
铝材和PC罩均为组合式安装, 宽度可订制, 可拆卸维护
最小拉弯半径: 内尺寸R > 200MM
材料长度: 3/6M
灯罩: 硅胶面罩/亚克力
拉弯方向: 侧弯下发光

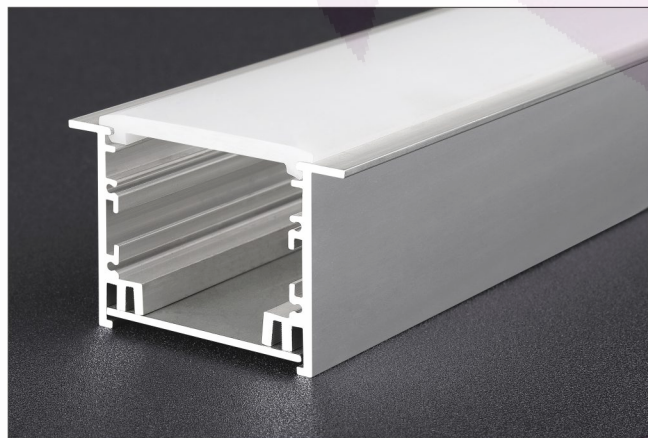
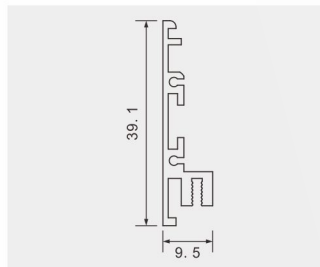

40A折弯

产品参数

嵌装组合款折弯线性灯

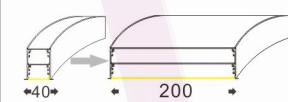

宽度可订制40-200MM*高度39MM
铝材和PC罩均为组合式安装, 宽度可订制, 可拆卸维护
最小拉弯半径: 内尺寸R > 200MM
材料长度: 3/6M
灯罩: 硅胶面罩/亚克力
拉弯方向: 侧弯下发光

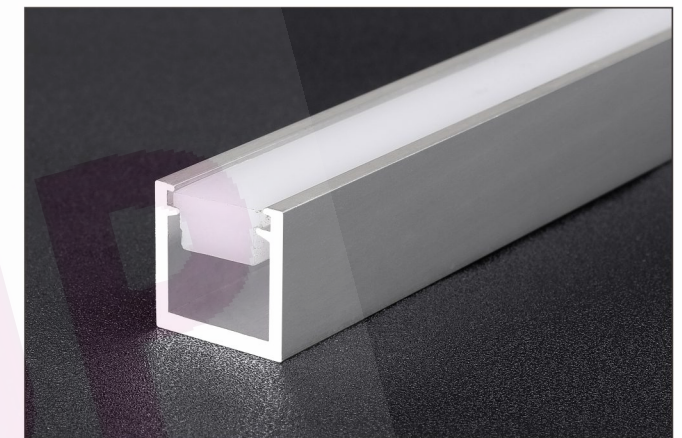
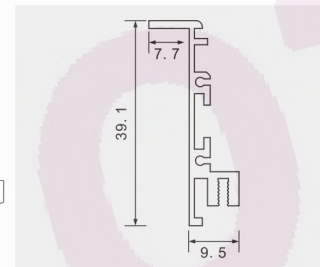

2020M地踩折弯

产品参数

折弯线性灯

尺寸: Lx20x20mm
材质: 6063-T5 铝合金
表面: 氧化铝本色/喷漆 (黑色/白色)
PC罩: 亚克力
适用: 16MM软灯带/硬灯条
最小折弯半径: 内尺寸R > 200MM
拉弯方向: 侧弯, 向下发光

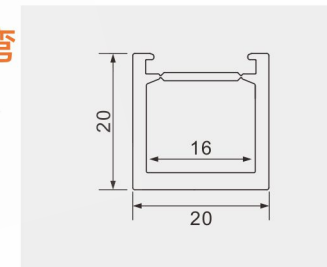

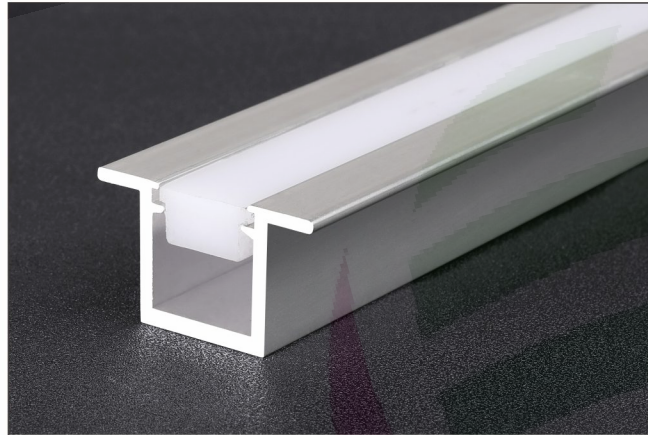

2020A地踩折弯

产品参数

折弯线性灯

尺寸: Lx34x20mm
材质: 6063-T5 铝合金
表面: 氧化铝本色/喷漆 (黑色/白色)
PC罩: 亚克力
适用: 16MM软灯带/硬灯条
最小折弯半径: 内尺寸R > 200MM
拉弯方向: 侧弯, 向下发光

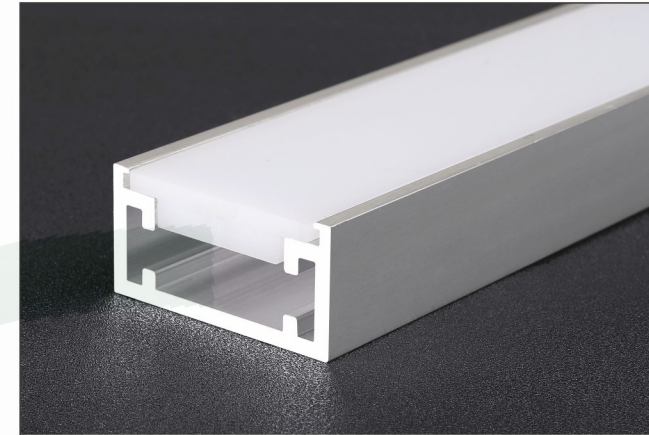
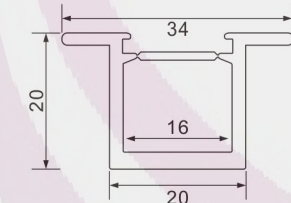

4020M地踩折弯

产品参数

折弯线性灯

尺寸: Lx40x20mm
材质: 6063-T5 铝合金
表面: 氧化铝本色/喷漆 (黑色/白色)
PC罩: 亚克力
适用: 23MM软灯带/硬灯条
最小折弯半径: 内尺寸R > 200MM
拉弯方向: 侧弯, 向下发光

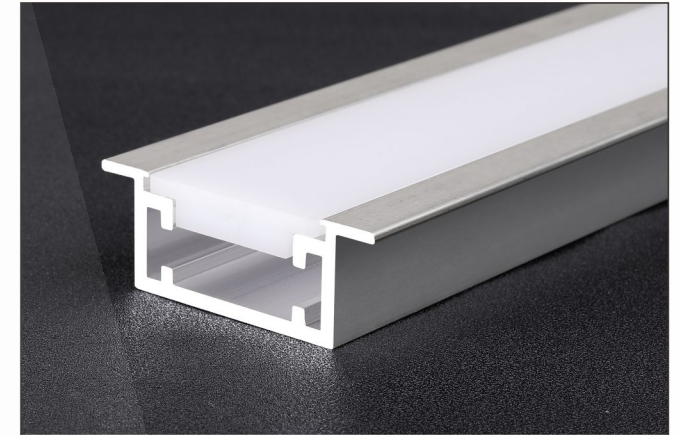
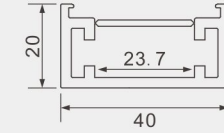

4020A地踩折弯

产品参数

折弯线性灯

尺寸: Lx54x20mm
材质: 6063-T5 铝合金
表面: 氧化铝本色/喷漆 (黑色/白色)
PC罩: 亚克力
适用: 23MM软灯带/硬灯条
最小折弯半径: 内尺寸R > 200MM
拉弯方向: 侧弯, 向下发光

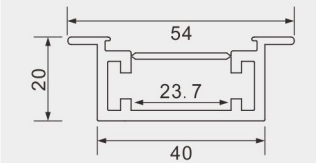

3020M地踩折弯

产品参数

折弯线性灯

尺寸: Lx30x20mm
材质: 6063-T5 铝合金
表面: 氧化铝本色/喷漆 (黑色/白色)
PC罩: 亚克力
适用: 26MM软灯带/硬灯条
最小折弯半径: 内尺寸R > 200MM
拉弯方向: 侧弯, 向下发光

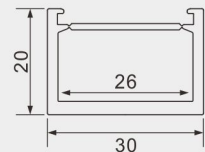

3020A地踩折弯

产品参数

折弯线性灯

尺寸: Lx43.5x20mm
材质: 6063-T5 铝合金
表面: 氧化铝本色/喷漆 (黑色/白色)
PC罩: 亚克力
适用: 26MM软灯带/硬灯条
最小折弯半径: 内尺寸R > 200MM
拉弯方向: 侧弯, 向下发光

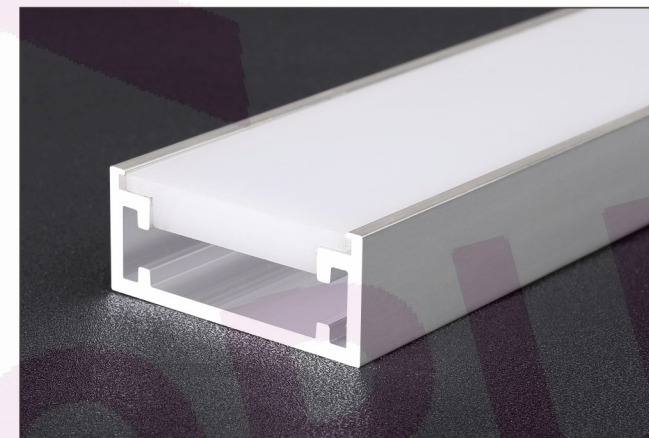
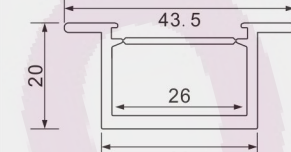

5020M地踩折弯

产品参数

折弯线性灯

尺寸: Lx48x20mm
材质: 6063-T5 铝合金
表面: 氧化铝本色/喷漆 (黑色/白色)
PC罩: 亚克力
适用: 31MM软灯带/硬灯条
最小折弯半径: 内尺寸R > 200MM
拉弯方向: 侧弯, 向下发光

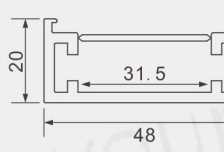

5020A地踩折弯

产品参数

折弯线性灯

尺寸: Lx62x20mm
材质: 6063-T5 铝合金
表面: 氧化铝本色/喷漆 (黑色/白色)
PC罩: 亚克力
适用: 31MM软灯带/硬灯条
最小折弯半径: 内尺寸R > 200MM
拉弯方向: 侧弯, 向下发光

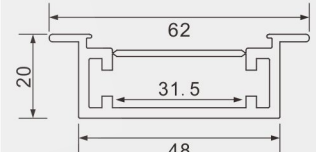

软灯带光源



欧司朗灯珠软灯带
电压: 直流DC12V / 24V(可选)
功率: 15W/米
灯珠: 2835 120珠/米
宽度: 8mm
长度: 5m/卷
色温: 3000K/4000K/6000K
显指: RA90

硬灯条光源



欧司朗灯珠硬灯条
电压: 直流DC12V / 24V(可选)
功率: 16W/米
灯珠: 2835 144珠/米
宽度: 12mm
长度: 1000mm
色温: 3000K/4000K/6000K
显指: RA90

台湾明纬开关电源



LRS-35 恒压 12V/24V/48V



LRS-50 恒压 12V/24V/48V



LRS-75 恒压 12V/24V/48V



LRS-100 恒压 12V/24V/48V



LRS-150 恒压 12V/24V/48V



LRS-200 恒压 12V/24V/48V



LRS-350 恒压 12V/24V/48V

磁吸灯内置电源



KR-100瓦 恒压 48V



KR-200瓦 恒压 48V

转角配件



PC接头:509转角
内空尺寸: 17.4*7MM



PC接头:613转角
内空尺寸: 17.2*14.4MM



PC接头:601转角
内空尺寸: 15.8*15.8MM

连接片

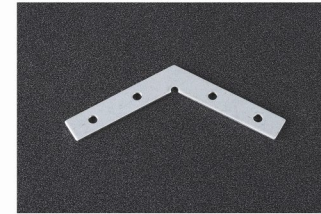

120度连接片
50mm*10mm*2mm 内六角M4螺丝



135度连接片
50mm*10mm*2mm 内六角M4螺丝

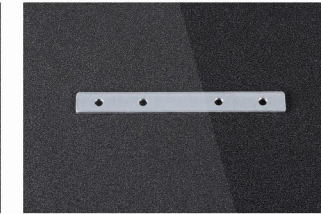

180度连接片
100mm*10mm*2mm 内六角M4螺丝

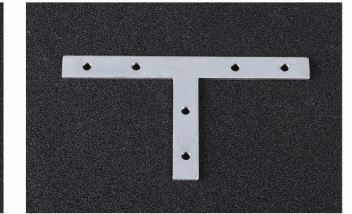

T字连接片
100mm*10mm*2mm 内六角M4螺丝

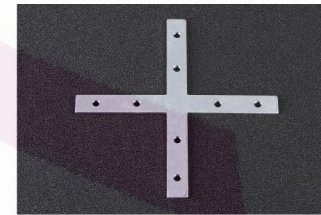

十字连接片
100mm*10mm*2mm 内六角M4螺丝

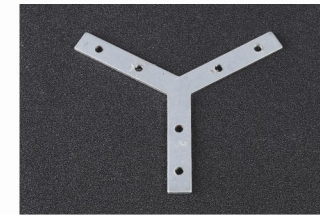

Y字连接片
100mm*10mm*2mm 内六角M4螺丝



90度平拼连接片
50mm*10mm*2mm 内六角M4螺丝



90度7字连接片
50mm*10mm*2mm 内六角M4螺丝

吊线、卡扣、卡簧

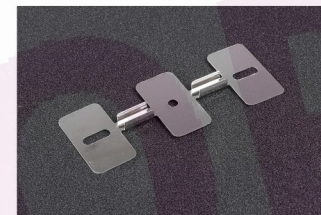

王字卡扣(吸顶用)



吊线



单边卡簧(嵌装开孔用)



10公分卡簧(嵌装开孔用)

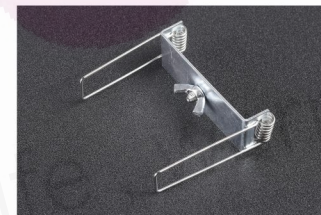

7公分卡簧(嵌装开孔用)

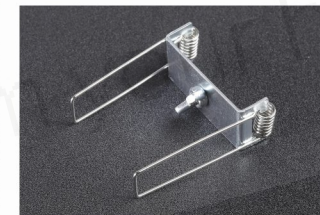

5公分卡簧(嵌装开孔用)



4公分卡簧(嵌装开孔用)



3公分卡簧(嵌装开孔用)